

n≈ 1450 rpm

پمپ 32 WKLV4, WKL 4

تیپ پمپ	توان P		آمپر A	قطر پروانه D (mm)	قطر فلنج mm		Q								
	KW	HP			مکش	رانس	آبدھی								
			m3/h				2	3	3.5	4	4.5	5	5.5	6	
						l/s	0.55	0.83	0.97	1.11	1.25	1.39	1.52	1.67	
WKLV4 32.1 D	0.25	0.34	0.7	125				5.6	5.1	4.8	4.4	4	3.5	*	*
WKLV4 32.1 C	0.25	0.34	0.7	130				6.2	5.8	5.5	5.1	4.7	4.2	3.7	*
WKLV4 32.1 B	0.25	0.34	0.7	135				6.7	6.3	6	5.6	5.2	4.7	4.2	*
WKLV4 32.1 A	0.25	0.34	0.7	140				7.5	7.1	6.8	6.4	6	5.5	5	4.5
WKLV4 32.2 D	0.37	0.5	1	125				11	10.2	9.7	9	8.1	7.1	*	*
WKLV4 32.2 C	0.37	0.5	1	130				12.3	11.5	11	10.3	9.5	8.6	7.6	*
WKLV4 32.2 B	0.37	0.5	1	135				13.5	12.6	12	11.4	10.6	9.7	8.7	*
WKLV4 32.2 A	0.37	0.5	1	140				14.7	14	13.3	12.6	11.8	11	10	9
WKLV4 32.3 D	0.55	0.75	1	125				16.2	15.3	14.6	13.6	12.5	11	*	*
WKLV4 32.3 C	0.55	0.75	1	130				18	17.2	16.5	15.6	14.5	13	11.4	*
WKLV4 32.3 B	0.55	0.75	1	135				20	19	18.3	17.3	16.2	14.8	13	*
WKLV4 32.3 A	0.75	1	2	140				21.8	21	20.2	19.2	18	16.7	15.2	13.6
WKLV4 32.4 D	0.75	1	2	125				22.3	20.5	19.2	17.6	16	14	*	*
WKLV4 32.4 C	0.75	1	2	130				24.4	22.7	21.5	20	18.5	16.8	14.7	*
WKLV4 32.4 B	0.75	1	2	135				26.7	25	23.8	22.4	20.8	19.2	17.2	*
WKLV4 32.4 A	1.1	1.5	3	140				29.2	27.7	26.5	25.2	23.7	22	20.2	18.2
WKLV4 32.5 D	1.1	1.5	3	125				28	25.7	24	22	20	18	*	*
WKLV4 32.5 C	1.1	1.5	3	130				30.5	28.4	26.8	25	23	20.8	18.4	*
WKLV4 32.5 B	1.1	1.5	3	135				33.7	31.5	30	28.3	26.4	24.4	22	*
WKLV4 32.5 A	1.1	1.5	3	140				35.8	34	32.7	31.2	29.5	27.5	25.3	23
WKLV4 32.6 D	1.1	1.5	3	125				33.8	30.8	29	26.5	23.8	20.8	*	*
WKLV4 32.6 C	1.1	1.5	3	130				36.8	34.2	32.3	30	27.6	24.8	21.7	*
WKLV4 32.6 B	1.1	1.5	3	135				40	37.5	35.8	33.8	31.3	28.8	25.8	*
WKLV4 32.6 A	1.5	2	4	140				43.6	41.4	39.7	38	35.5	33	30	27
WKLV4 32.7 D	1.1	1.5	3	125	40	32	H (m)	39	35.8	33.5	30.8	27.8	24	*	*
WKLV4 32.7 C	1.1	1.5	3	130				42.8	39.7	37.5	35	32.2	28.8	25.4	*
WKLV4 32.7 B	1.5	2	4	135				47	44	42	39.5	36.7	33.8	30.5	*
WKLV4 32.7 A	1.5	2	4	140				50.8	48	46.2	44	41.5	38.8	35.5	32
WKLV4 32.8 D	1.5	2	4	125				45	41.3	38.6	35.4	32	27.6	*	*
WKLV4 32.8 C	1.5	2	4	130				49	45.5	43	40	36.8	32.8	28.8	*
WKLV4 32.8 B	1.5	2	4	135				53.7	50.2	47.8	45	41.6	38.2	34.2	*
WKLV4 32.8 A	2.2	3	5	140				57.7	54.7	52.6	50	47	44	40.2	36
WKLV4 32.9 D	1.5	2	4	125				50.5	46.3	43.3	39.4	35.5	31	*	*
WKLV4 32.9 C	1.5	2	4	130				55	51.2	48.4	45.2	41.3	37.2	32.4	*
WKLV4 32.9 B	1.5	2	4	135				60	56.2	53.6	50.5	46.8	43	38.5	*
WKLV4 32.9 A	2.2	3	5	140				65.5	62	59.6	57	53.5	50	45.5	41
WKLV4 32.10 D	1.5	2	4	125				56	51.3	47.8	43.5	39	34	*	*
WKLV4 32.10 C	2.2	3	5	130				61.5	57	53.8	50	46	41	36	*
WKLV4 32.10 B	2.2	3	5	135				67.5	63	60	56.5	52.2	48	43	*
WKLV4 32.10 A	2.2	3	5	140				73	69	66.2	63	59	55	50.5	45
WKLV4 32.11 D	2.2	3	5	125				61	56.5	53	48.2	43.5	38	*	*
WKLV4 32.11 C	2.2	3	5	130				67	62.4	59	55	50.6	45	39.6	*
WKLV4 32.11 B	2.2	3	5	135				74	69.3	66	62	57.4	52.8	47.3	*
WKLV4 32.11 A	2.2	3	5	140				79.5	75.5	72.6	69	65	60.6	55.5	50
WKLV4 32.12 D	2.2	3	5	125				67	61.8	57.8	53.2	48	42	*	*
WKLV4 32.12 C	2.2	3	5	130				73.3	68	64.2	60	55.2	49.2	43.2	*
WKLV4 32.12 B	2.2	3	5	135				80	75.5	72	67.8	62.7	57.6	51.6	*
WKLV4 32.12 A	3	4	7	140				87	82.8	79.8	76	71	66	60.5	55

H	m	3.4	5.5	9.2	13.7	18.3	25.9	33.5	42.7	51.8	61	73.2	88.4
	ft	11	18	30	45	60	85	110	140	170	200	240	290

Q	m3/h	2	3	3.5	4	4.5	5	5.5	6
	g.p.m	7.5	11	13	15	17	19	21	23

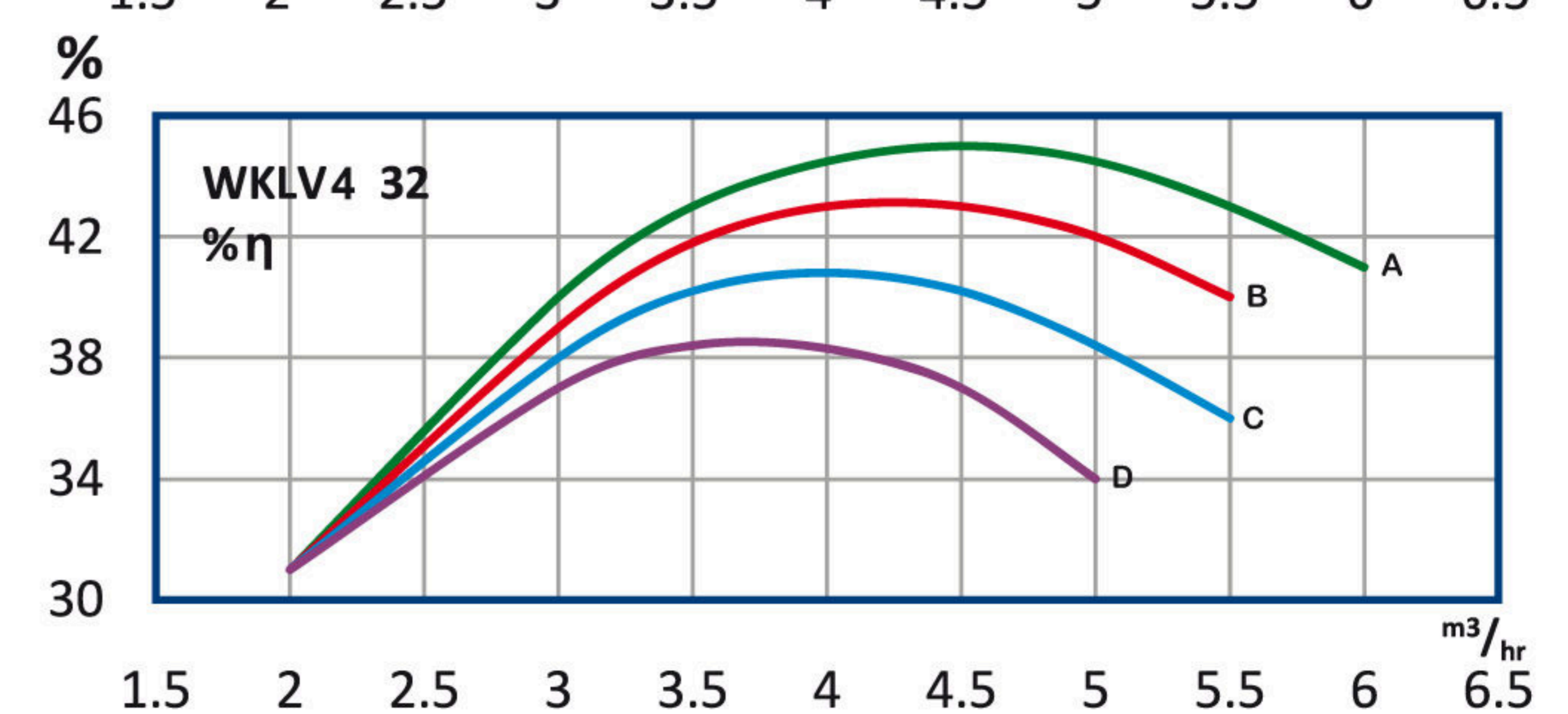
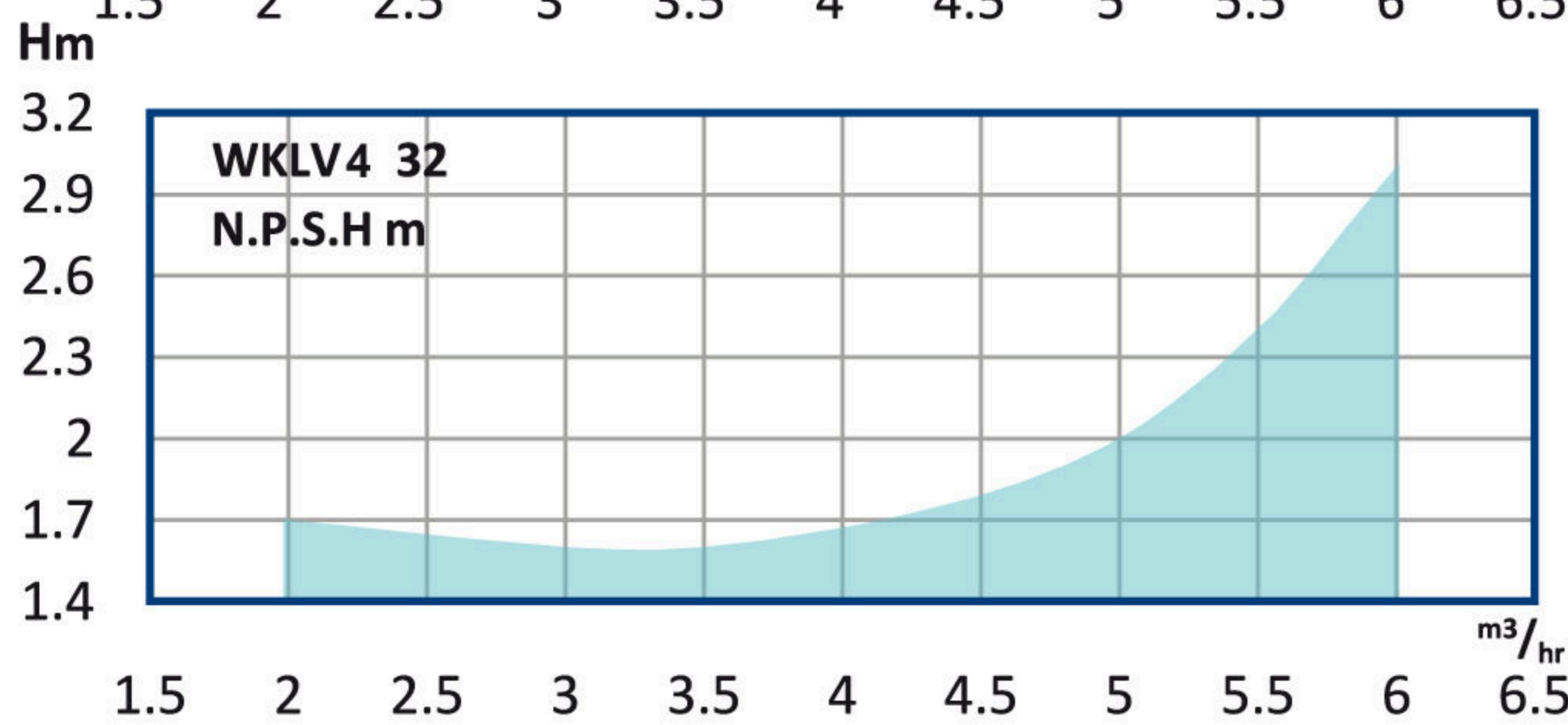
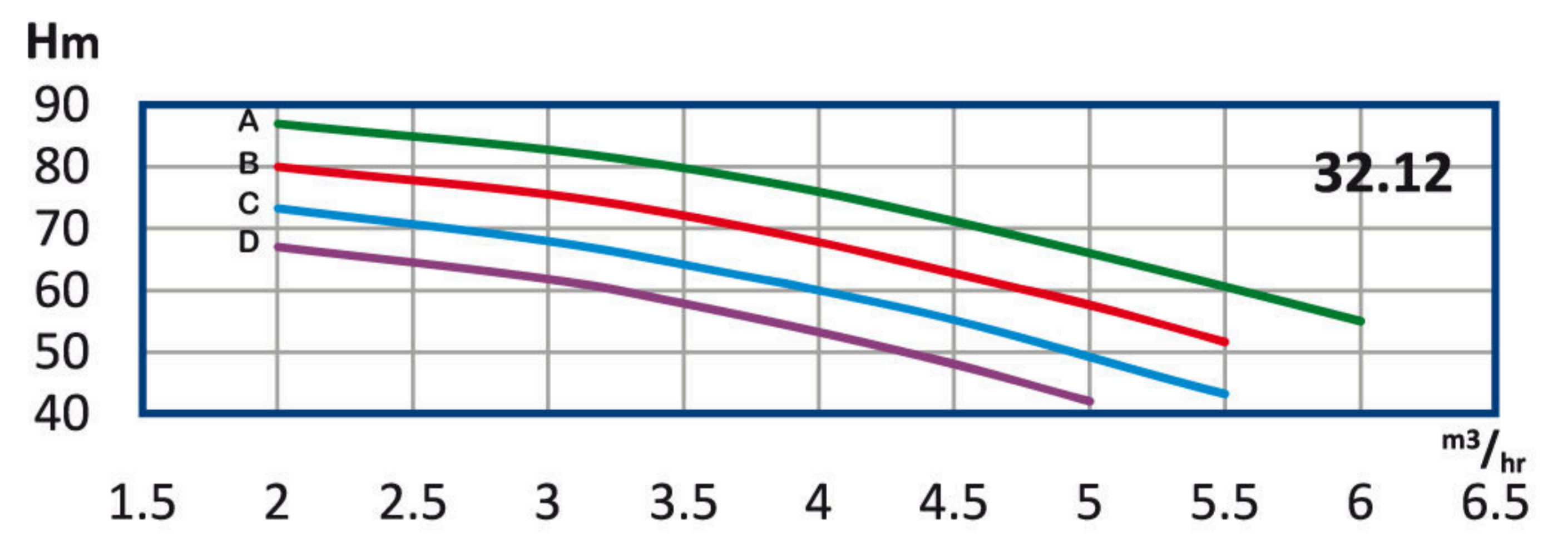
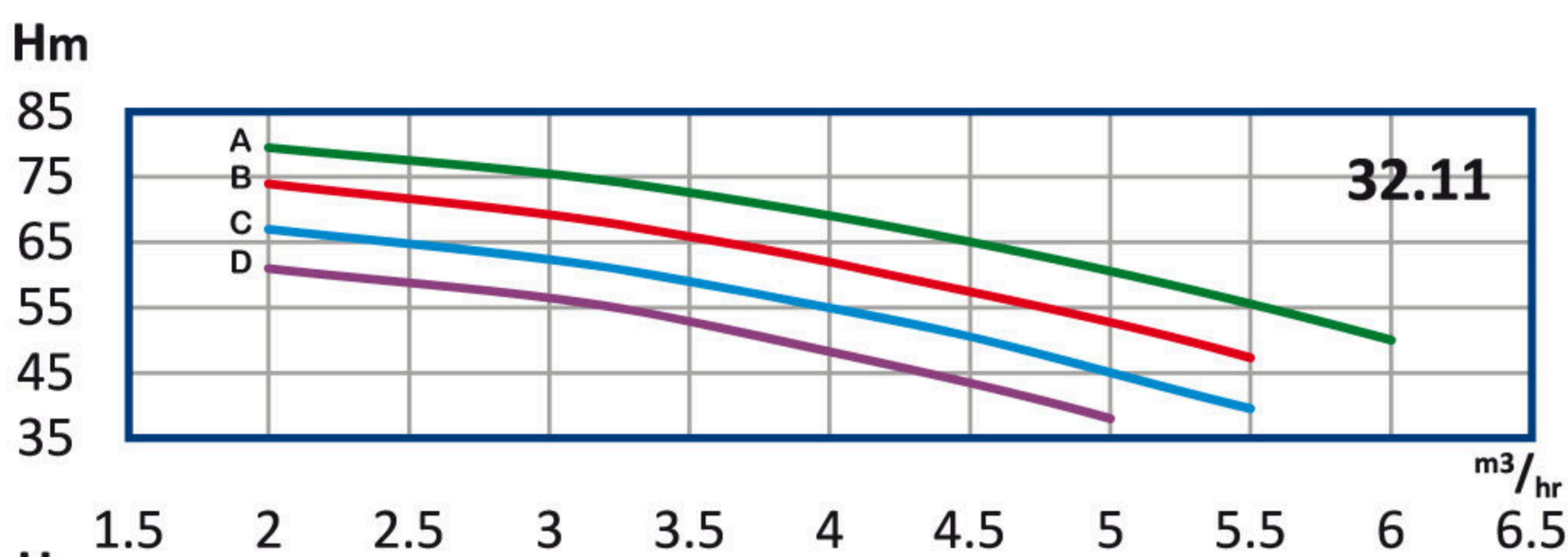
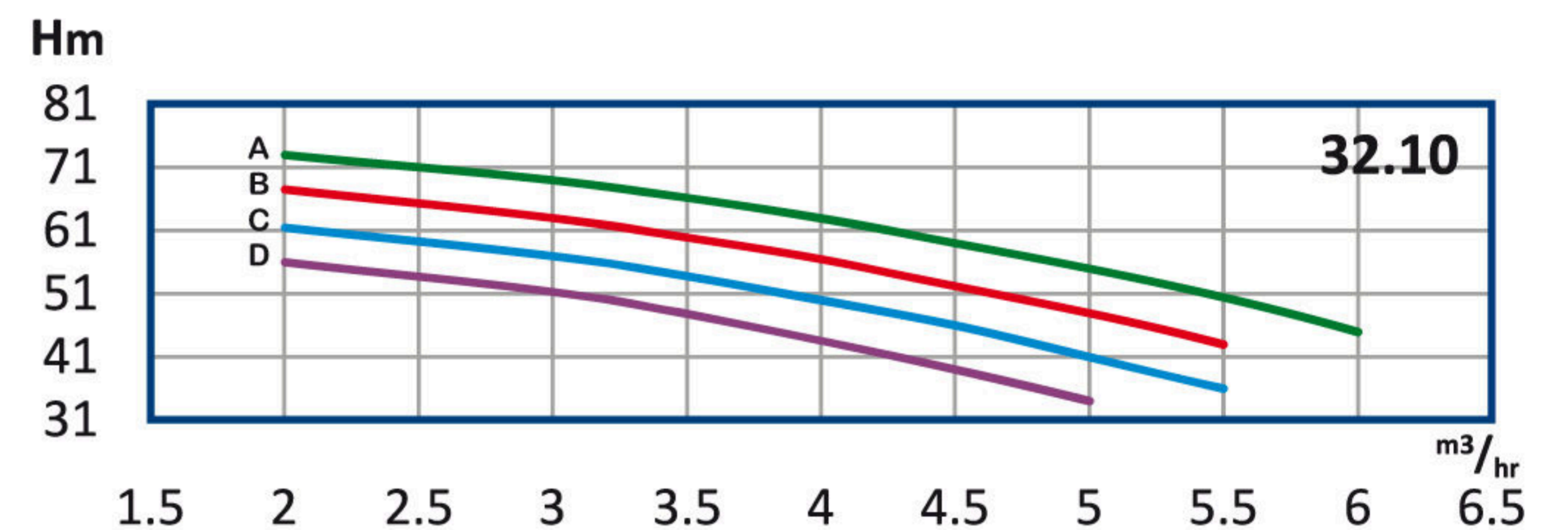
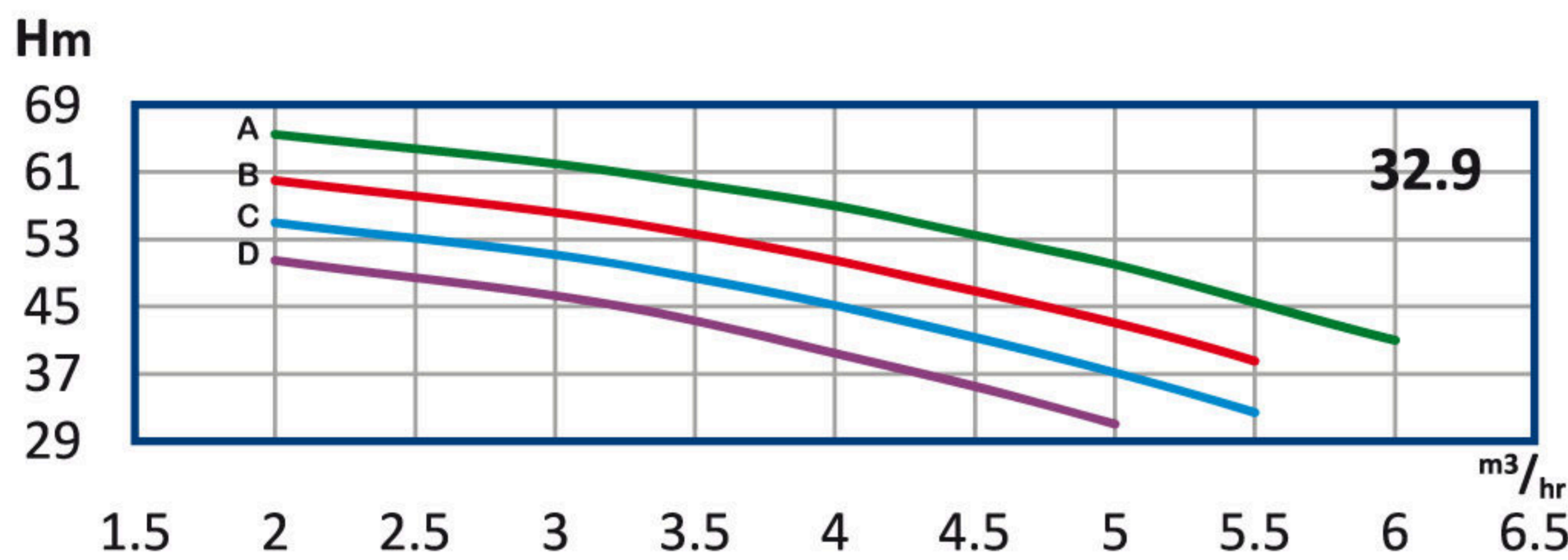
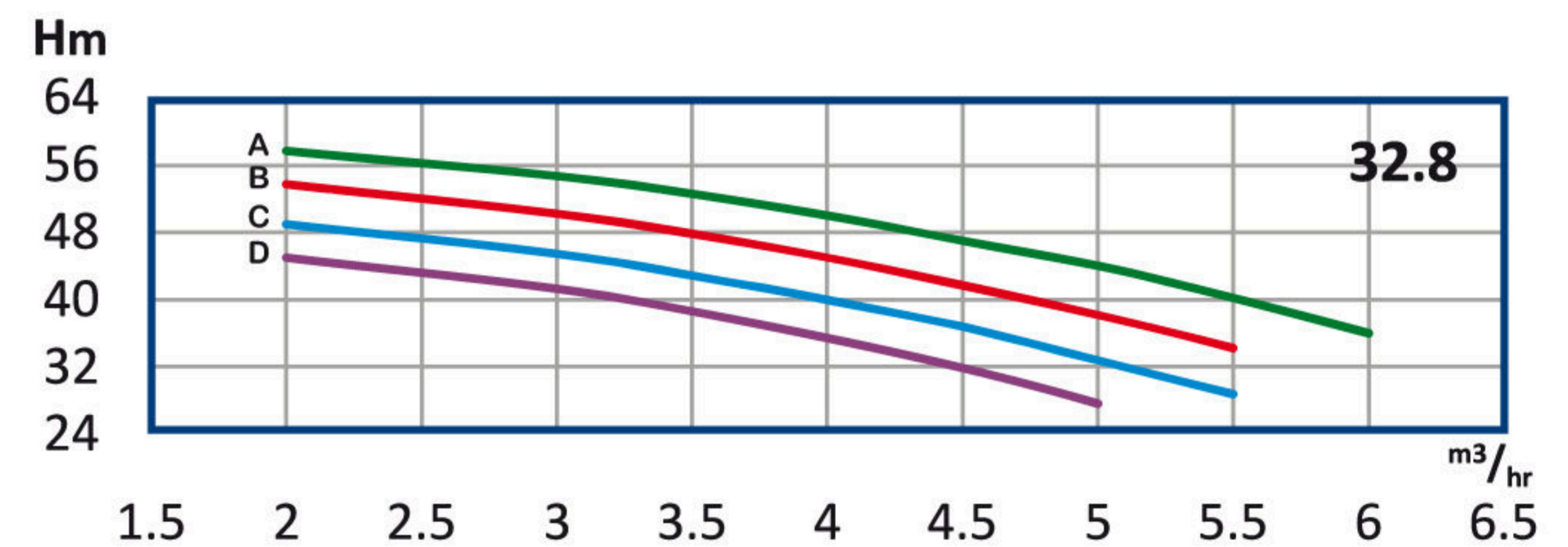
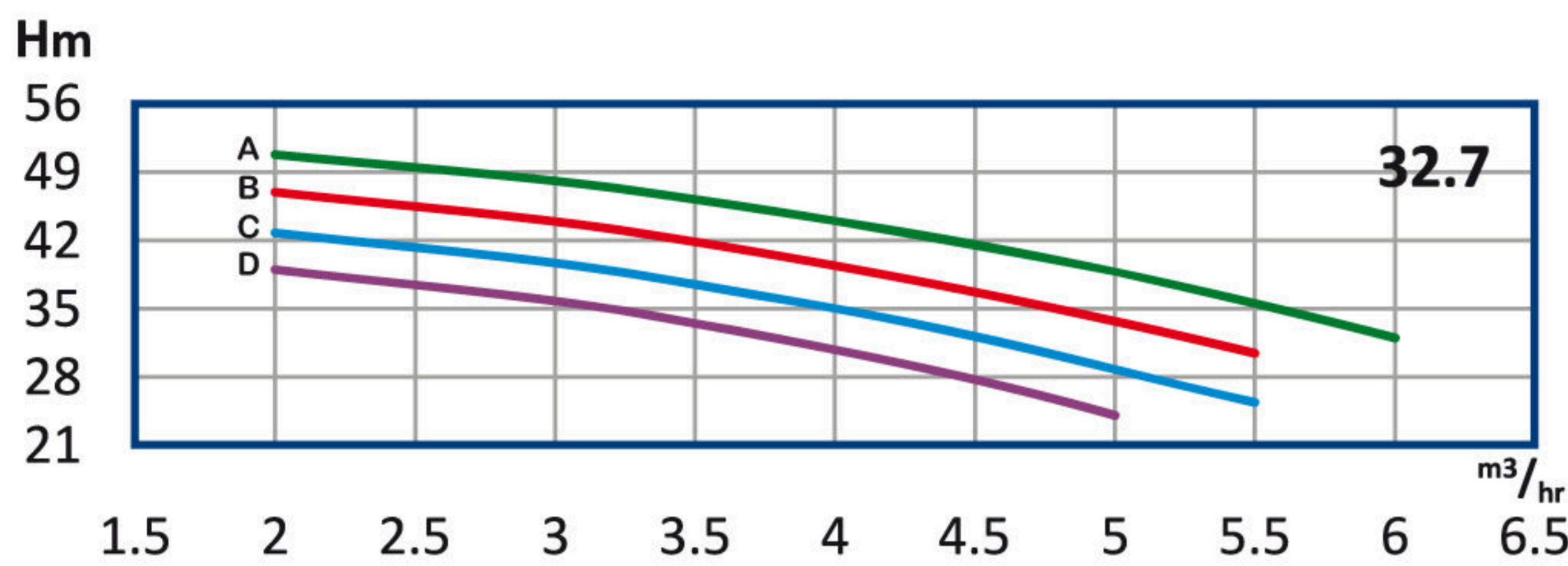
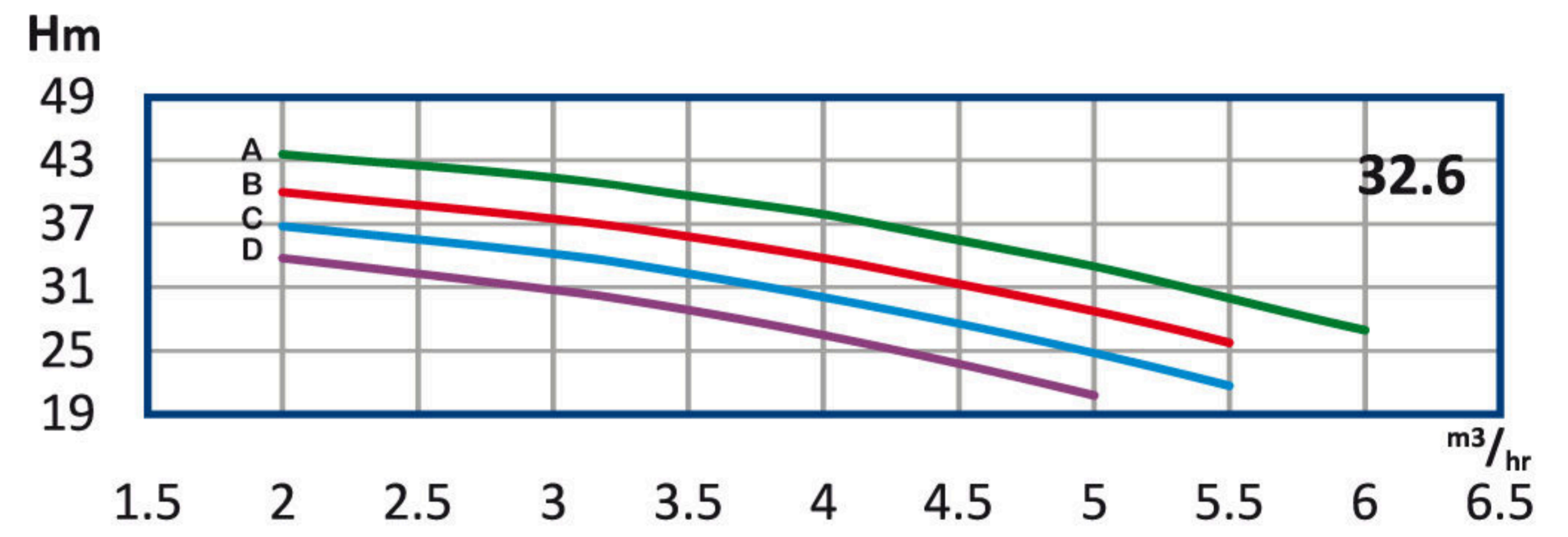
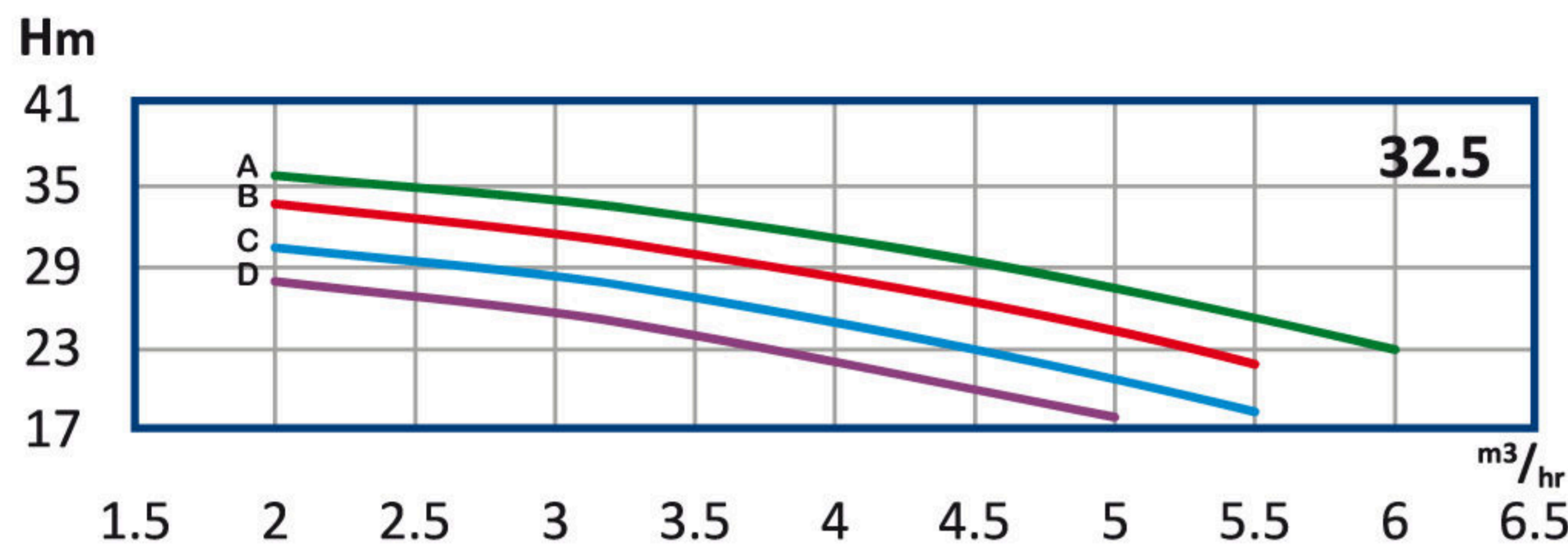
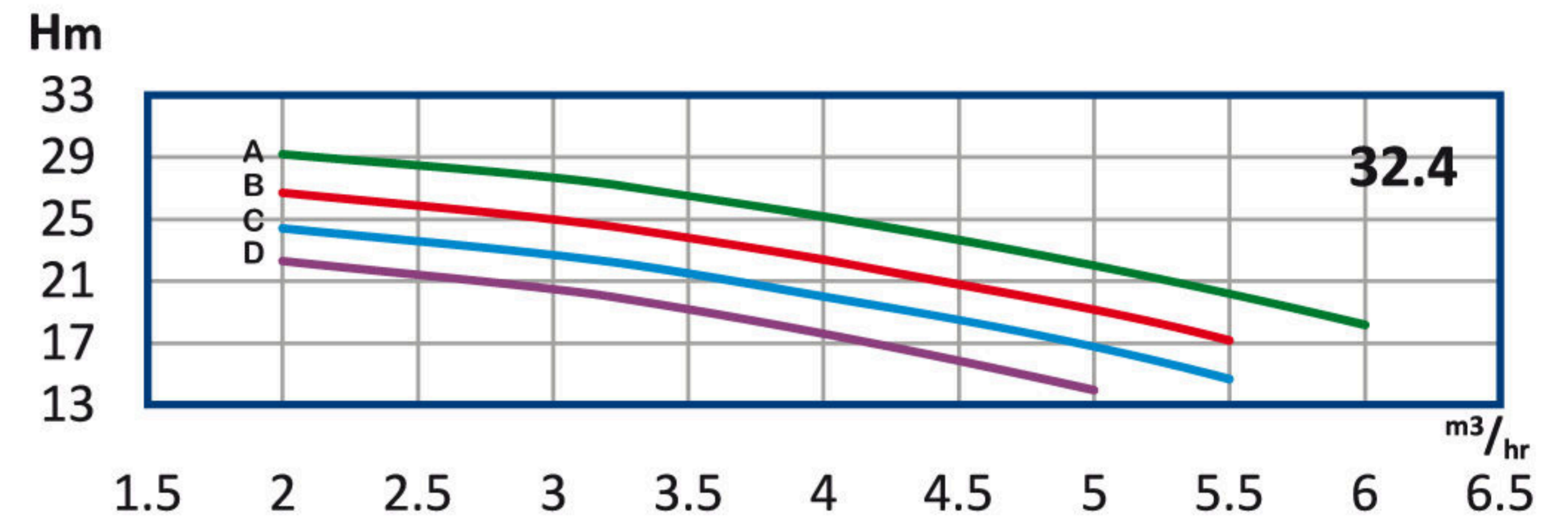
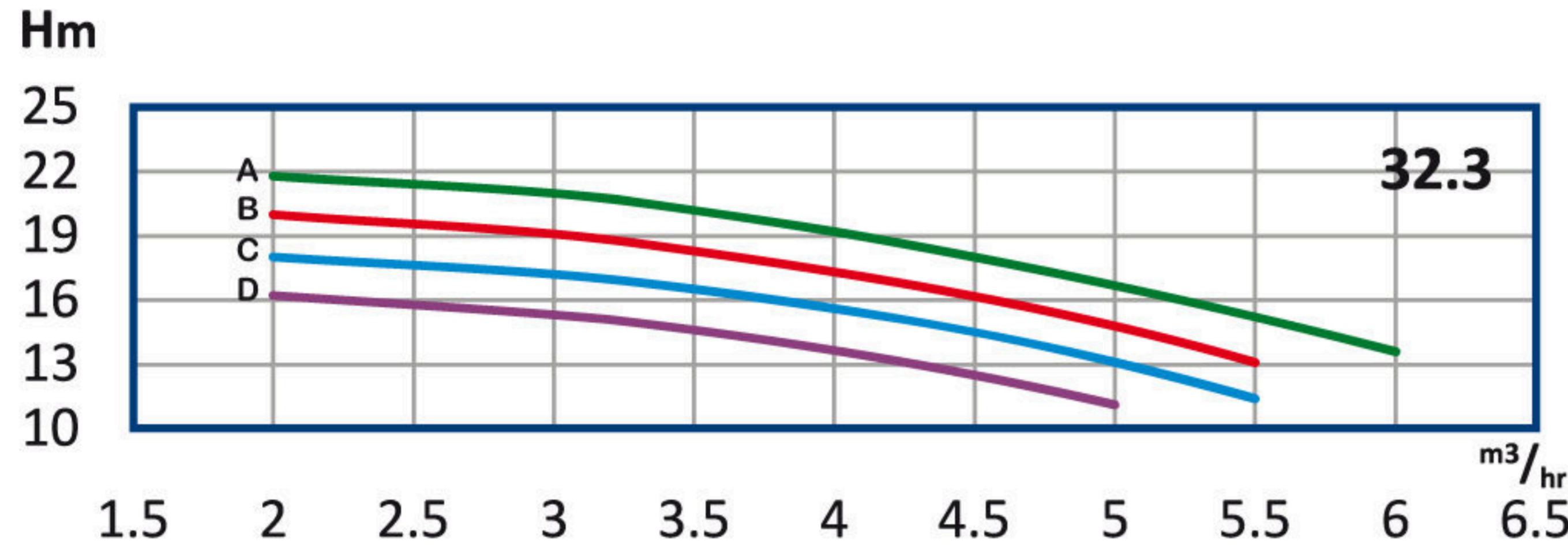
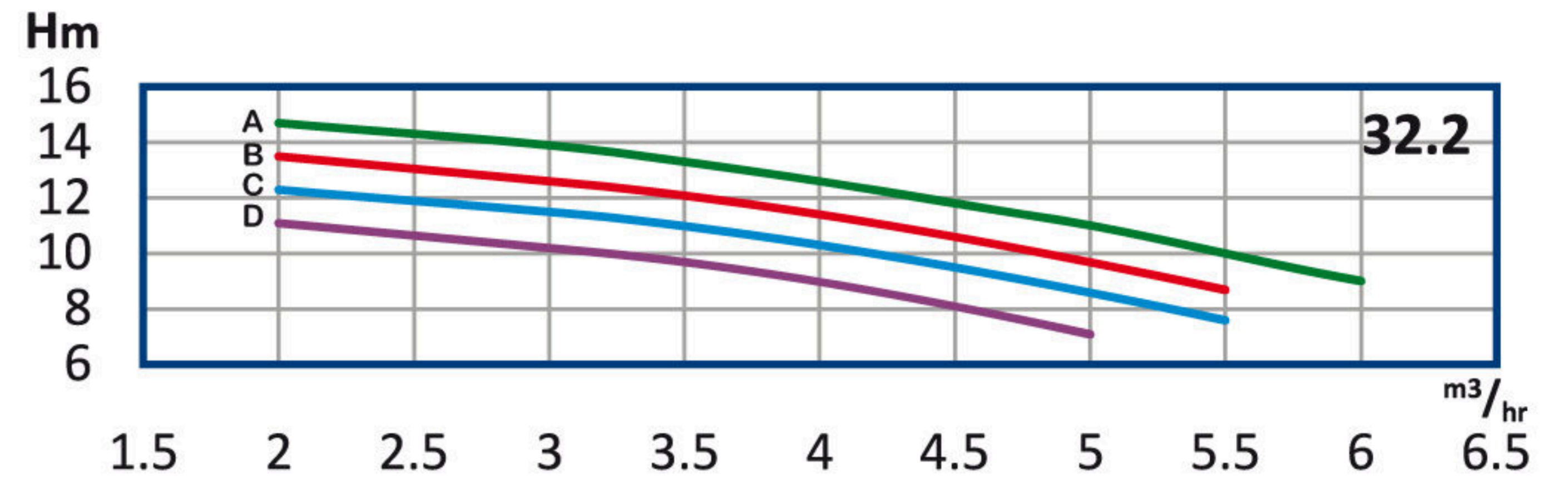
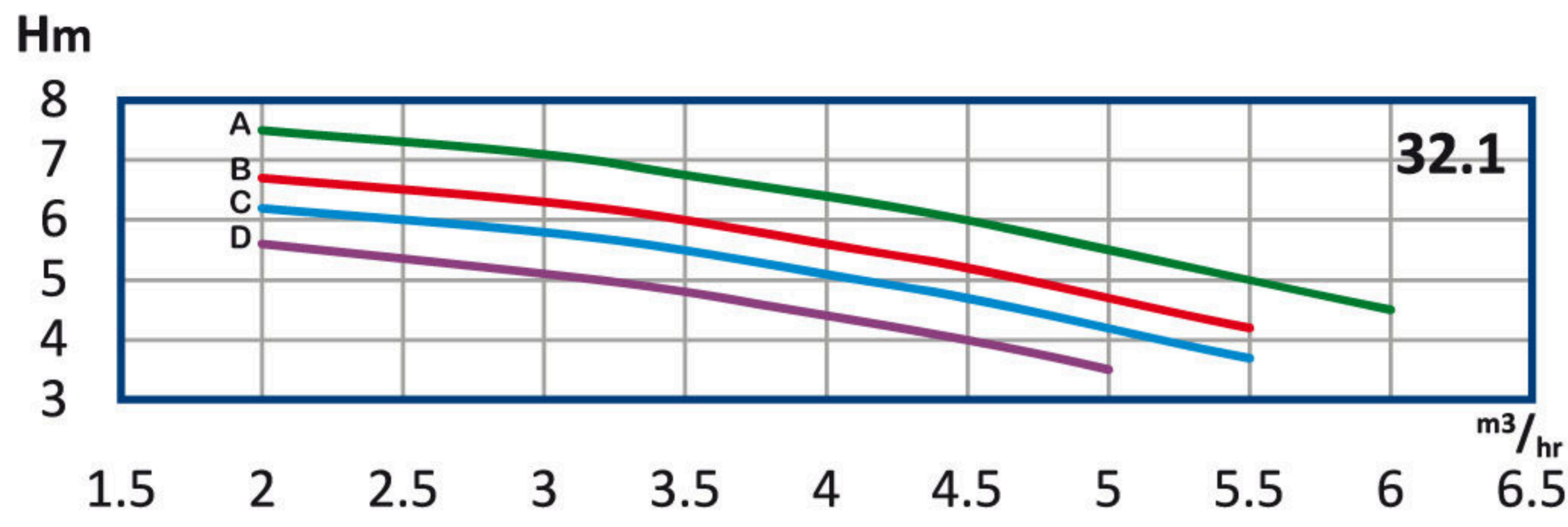

n ≈ 1450 rpm

پمپ 32 WKLV4, WKL 4

تیپ پمپ	توان P		آمپر A	قطر پروانه D (mm)	قطر فلنج mm		Q آبدھی								
	KW	HP			مکش	رانس	m ³ /h	2	3	3.5	4	4.5	5	5.5	6
							l/s	0.55	0.83	0.97	1.11	1.25	1.39	1.52	1.67
WKLV4 32.13 D	2.2	3	5	125	40	32	H (m)	73	67	62.3	56.8	50.8	44	*	*
WKLV4 32.13 C	2.2	3	5	130				80	74	70	65	59.8	53.3	46.8	*
WKLV4 32.13 B	2.2	3	5	135				87.7	81.8	78	73.4	68	62.4	56	*
WKLV4 32.13 A	3	4	7	140				95	90	86.3	82	77	72	65.7	59
WKLV4 32.14 D	2.2	3	5	125				78	72	67.2	61.7	55.8	48.8	*	*
WKLV4 32.14 C	2.2	3	5	130				86	79.8	75.2	70	64.5	57.4	50.4	*
WKLV4 32.14 B	3	4	7	135				94	88.4	84.2	79.2	73.2	67.2	60.2	*
WKLV4 32.14 A	3	4	7	140				102	97.3	93.3	88.4	82.5	77	70.5	64
WKLV4 32.15 D	2.2	3	5	125				84.5	77	72	65.8	59.2	52	*	*
WKLV4 32.15 C	3	4	7	130				92.2	85.5	80.5	75	69	61.5	54	*
WKLV4 32.15 B	3	4	7	135				101.2	94.5	90	84.7	78.3	72	64.5	*
WKLV4 32.15 A	3	4	7	140				109	103	98.6	94	88.5	82.7	75.8	69
WKLV4 32.16 D	3	4	7	125				89	82	76.4	70	63	55	*	*
WKLV4 32.16 C	3	4	7	130				98	91	86	80	73.6	65.6	57.6	*
WKLV4 32.16 B	3	4	7	135				107	100.5	96	90.2	83.5	76.8	68.8	*
WKLV4 32.16 A	4	5.5	9	140				116.5	110.2	106.5	101	94.5	88	80.8	73
WKLV4 32.17 D	3	4	7	125				94	87.4	81.4	74.5	67	59	*	*
WKLV4 32.17 C	3	4	7	130				104	97	91.4	85	78.2	69.7	61.2	*
WKLV4 32.17 B	3	4	7	135				114	107.2	102.2	96	88.8	81.6	73	*
WKLV4 32.17 A	4	5.5	9	140				124	117	112.4	107	100.5	94	86	78

H	m	42.7	48.8	55	61	67	76	85	94.5	104	113	125	134
	ft	140	160	180	200	220	250	280	310	340	370	410	440

Q	m ³ /h	2	3	3.5	4	4.5	5	5.5	6
	g.p.m	7.5	11	13	15	17	19	21	23

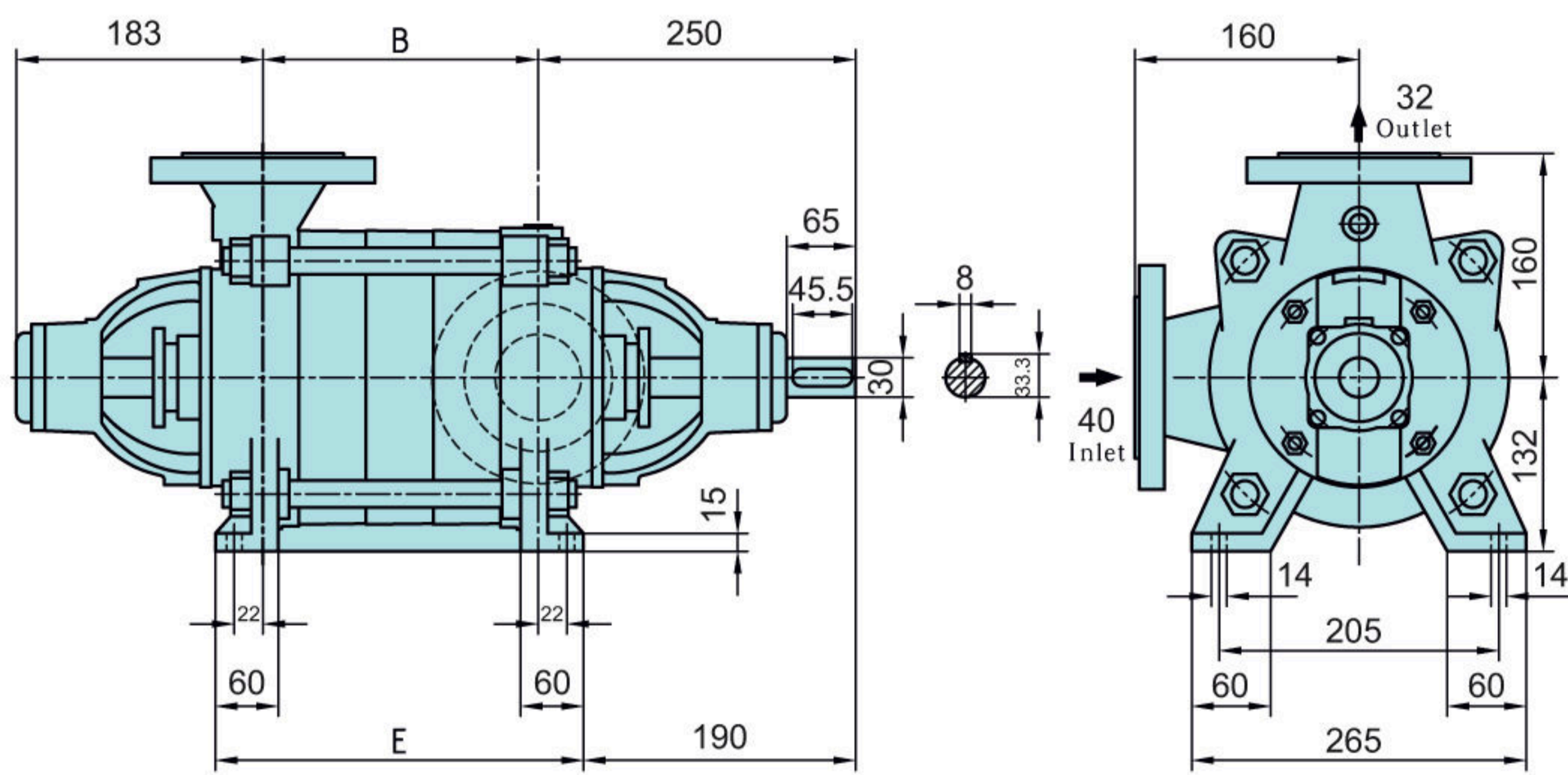
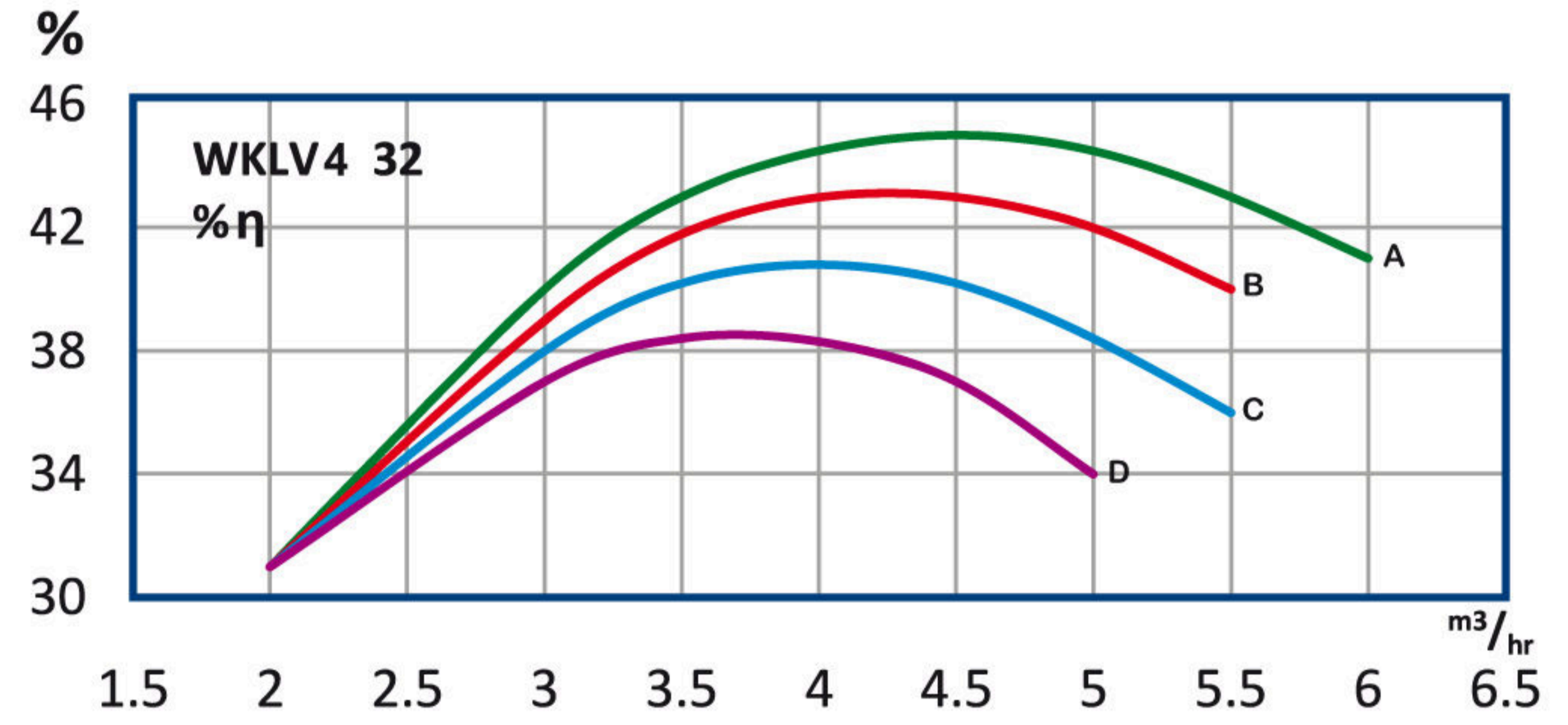
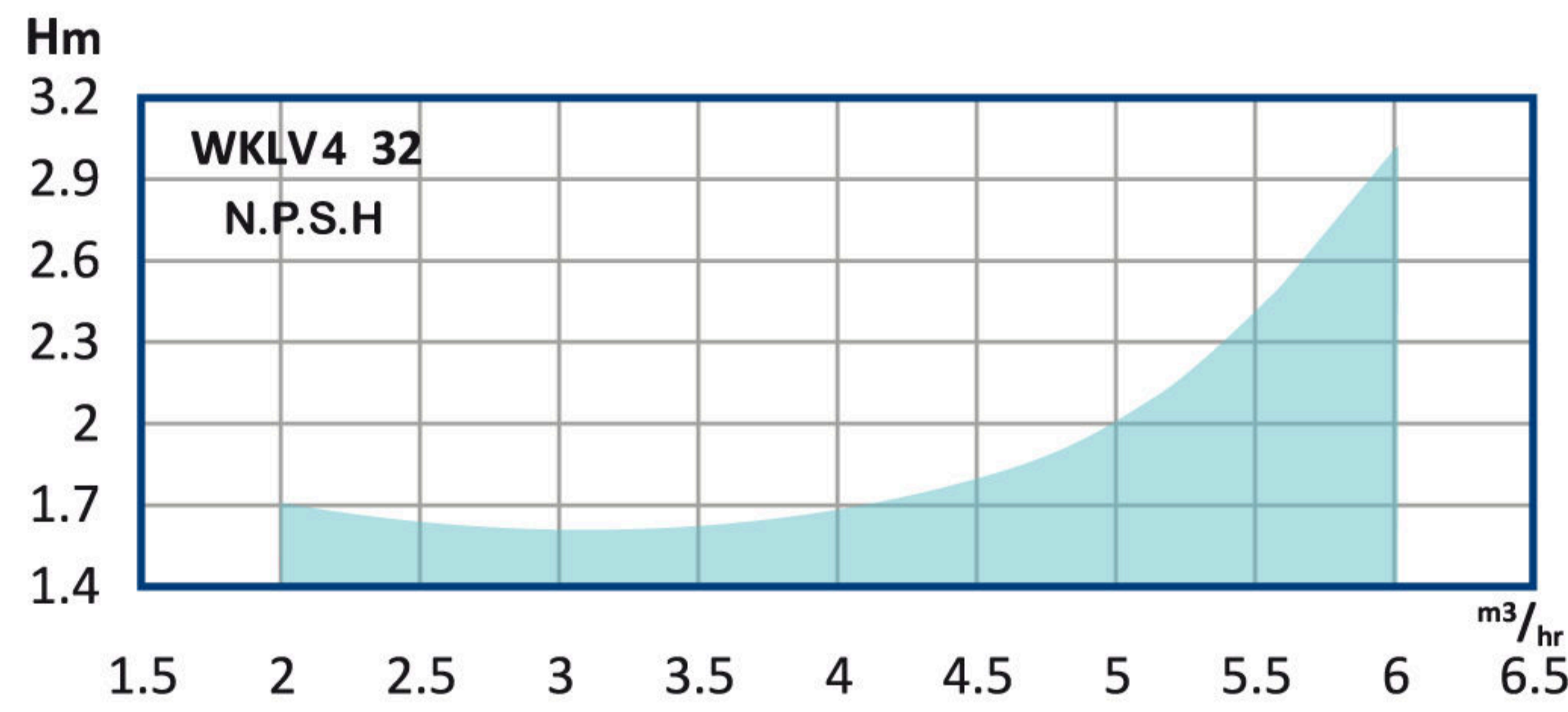
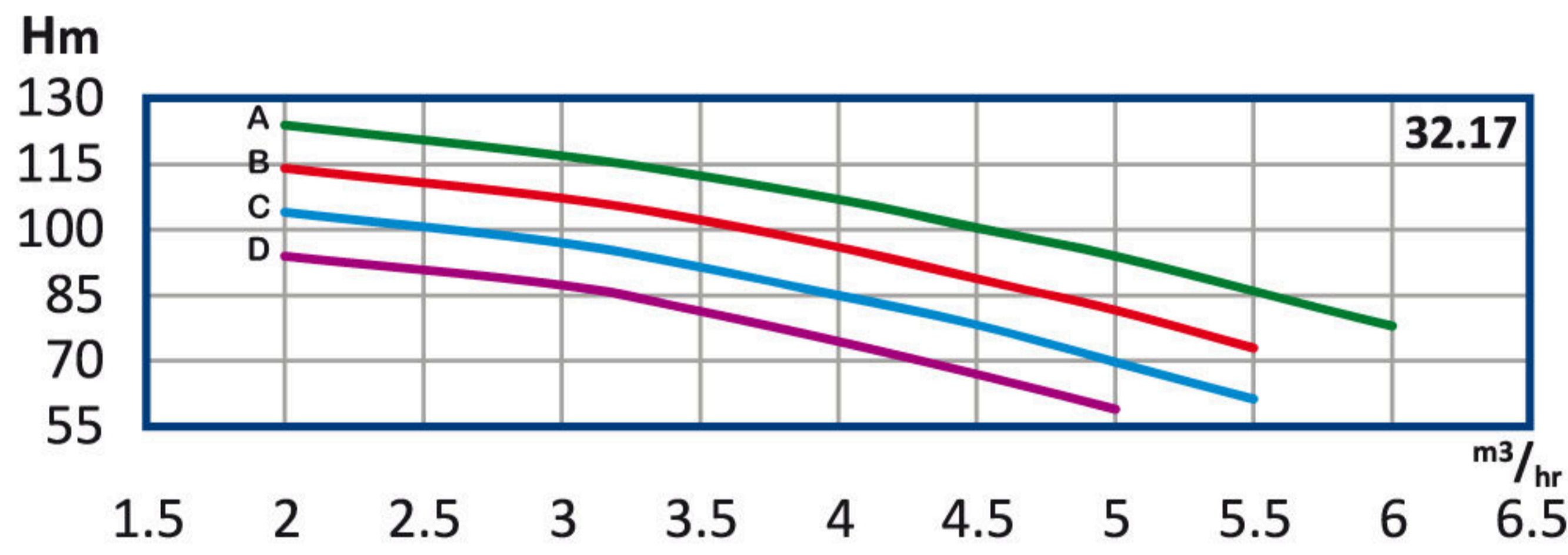
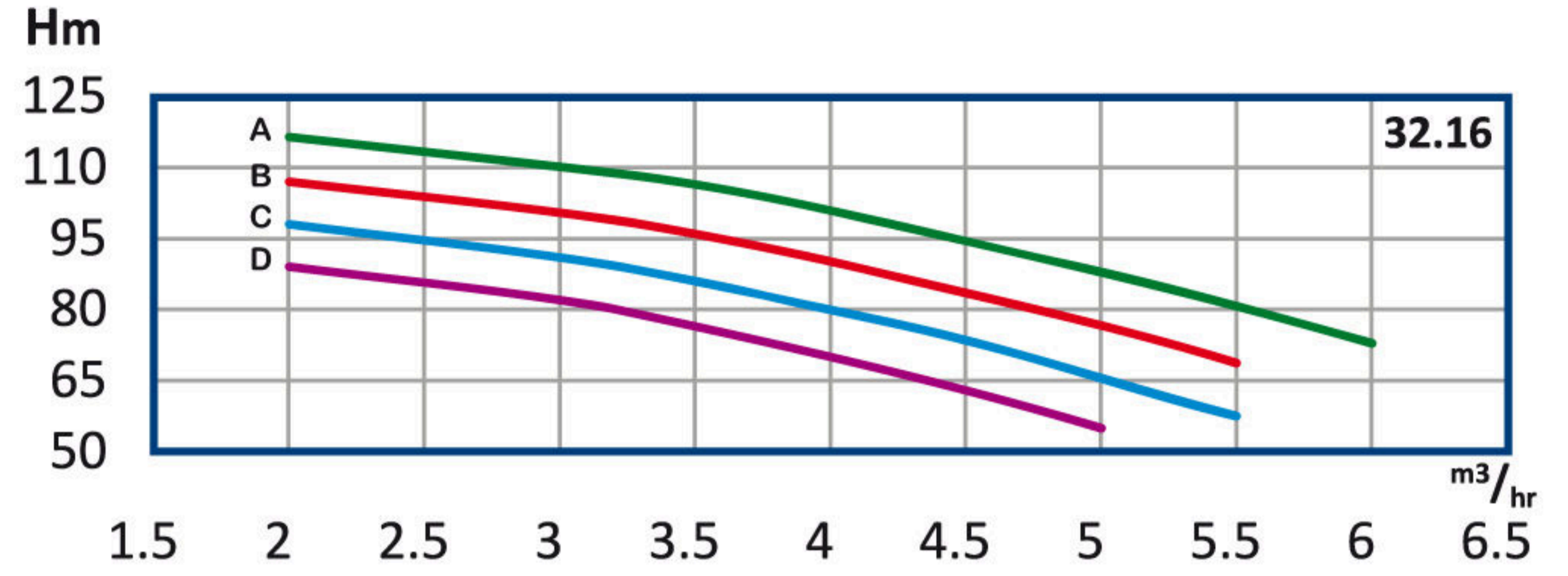
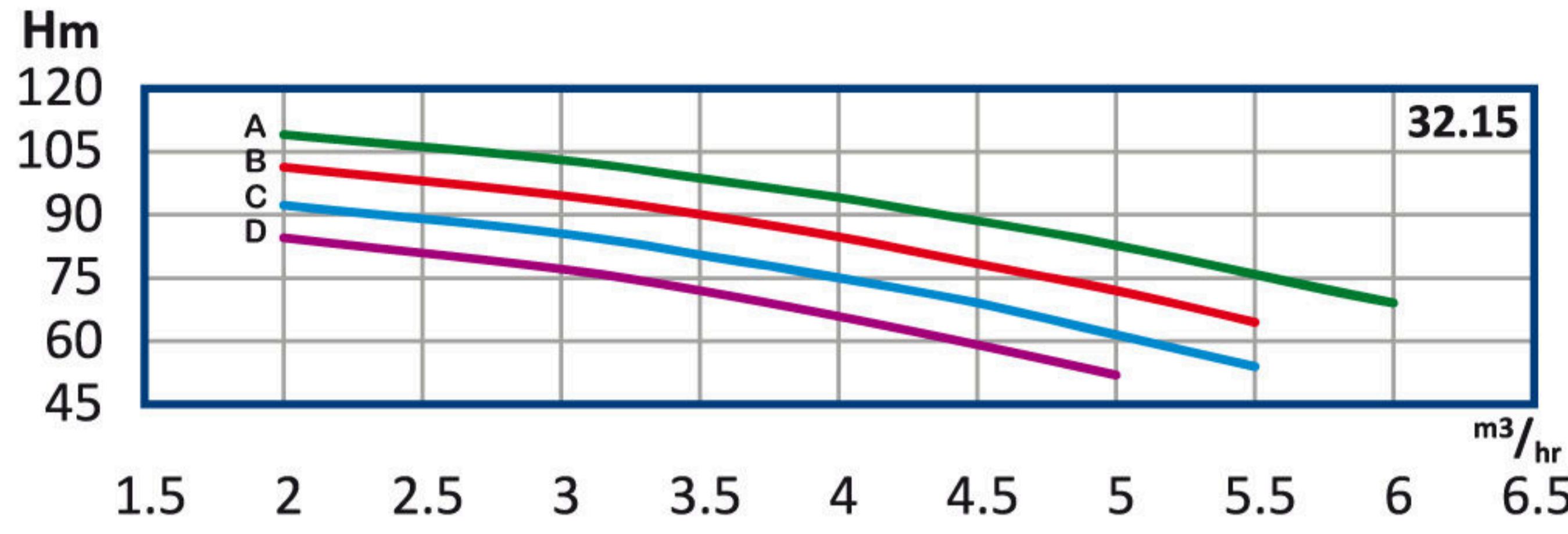
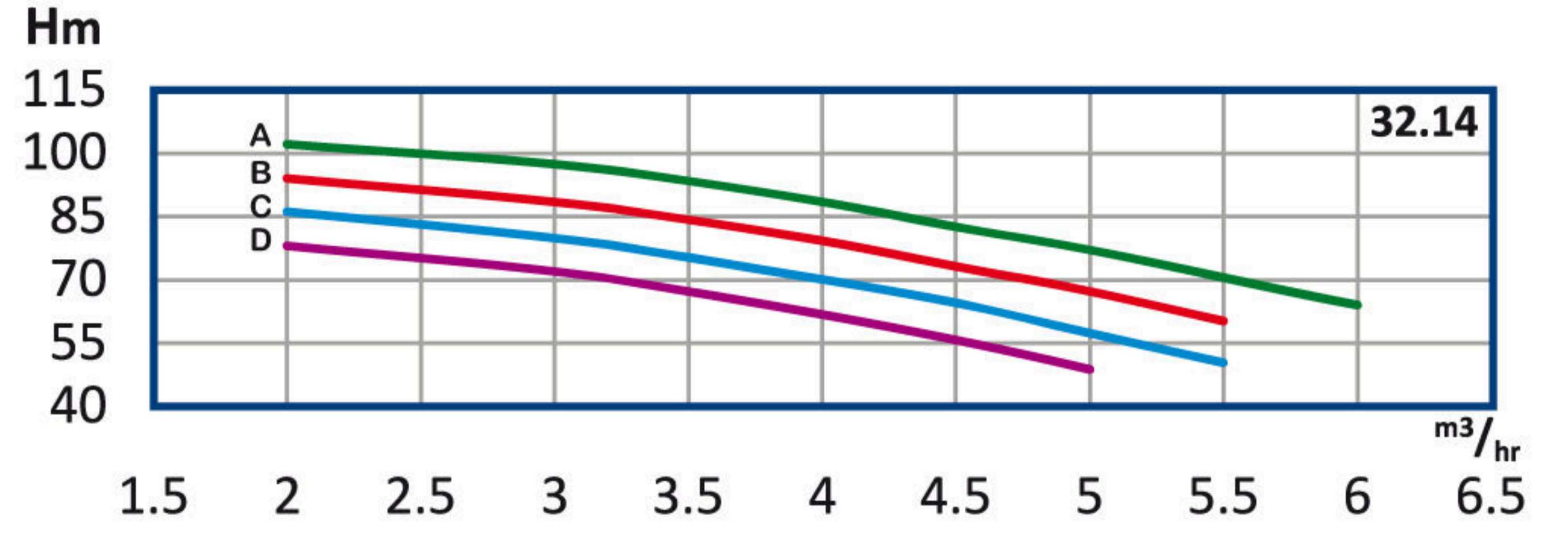
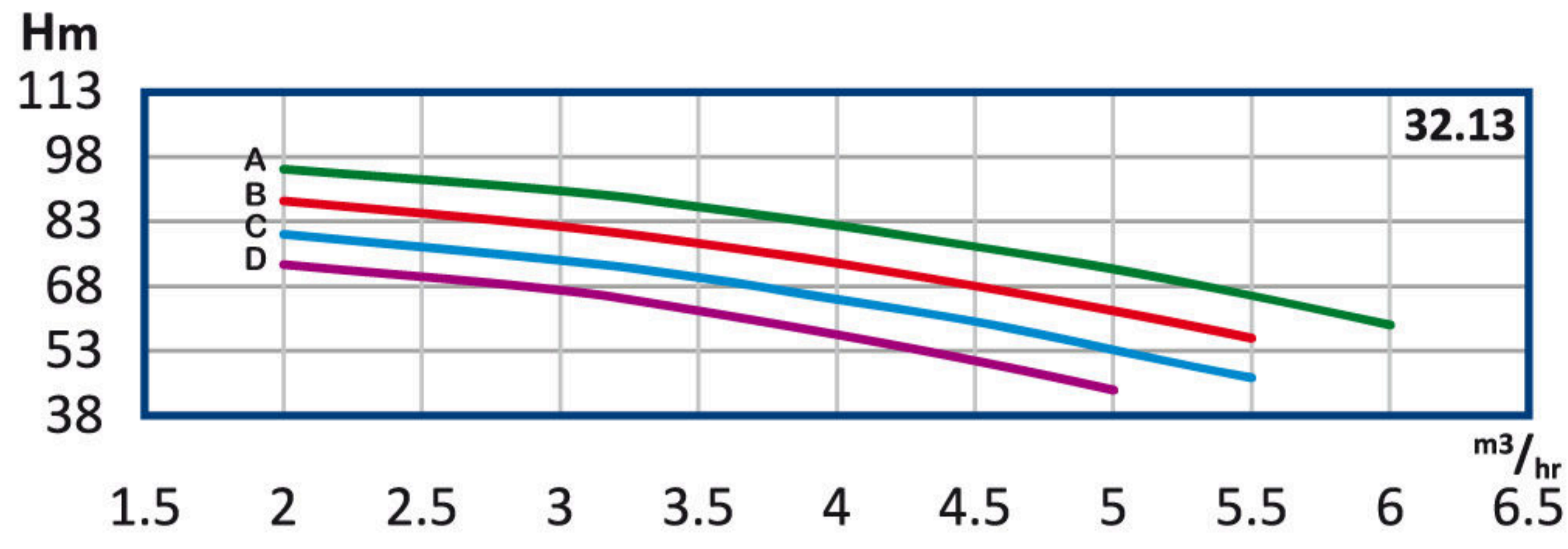

جدول طول پمپ WKL4 32 (mm)

تعداد طبقه	B	E	تعداد طبقه	B	E
1	82	202	10	514	634
2	130	250	11	562	682
3	178	298	12	610	730
4	226	346	13	658	778
5	274	394	14	706	826
6	322	442	15	754	874
7	370	490	16	802	922
8	418	538	17	850	970
9	466	586			

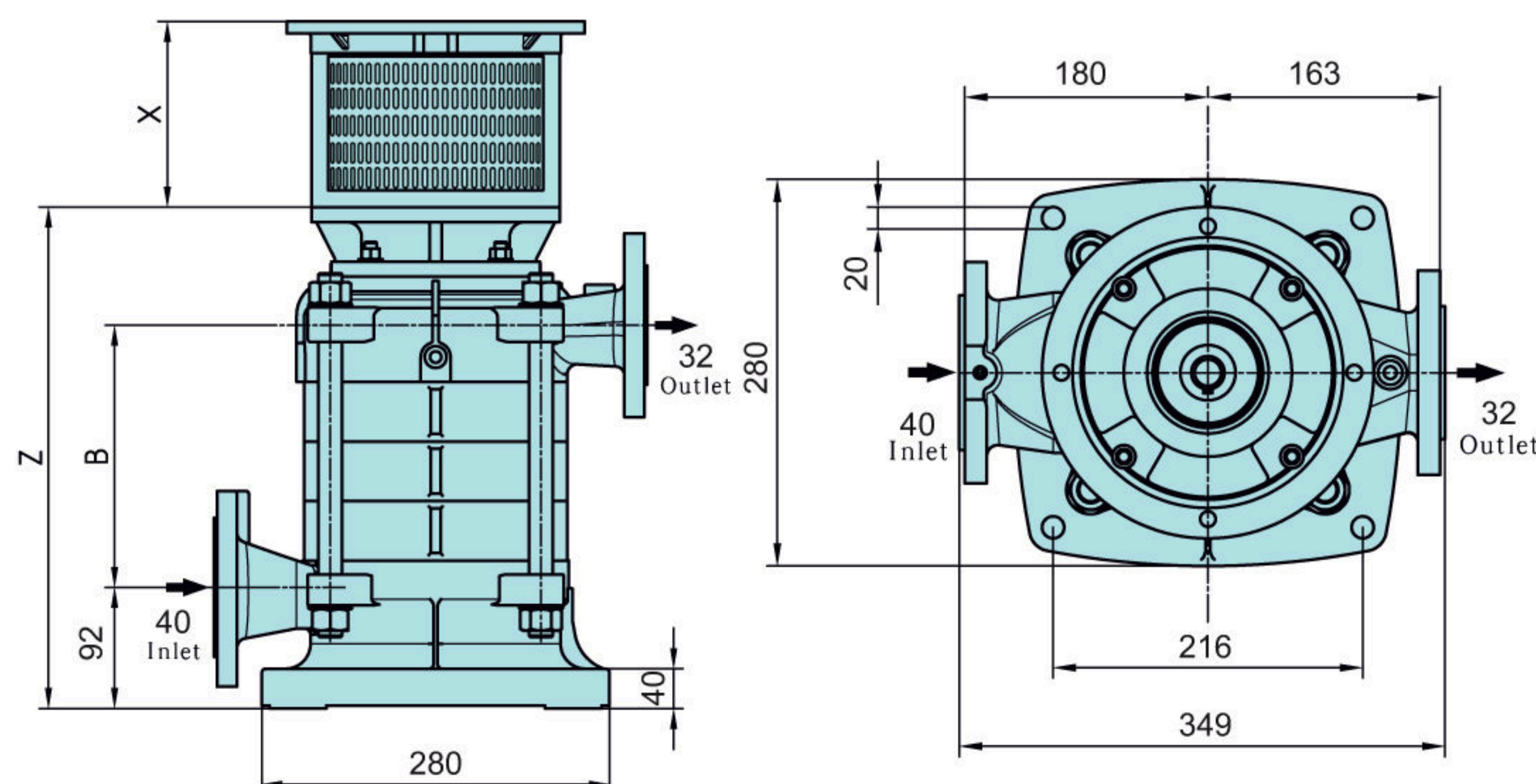

جدول طول پمپ WKL4 32 (mm)

تعداد طبقه	B	Z	تعداد طبقه	B	Z
1	76	279	10	508	711
2	124	327	11	556	759
3	172	375	12	604	807
4	220	423	13	652	855
5	268	471	14	700	903
6	316	519	15	748	951
7	364	567	16	796	999
8	412	615	17	844	1047
9	460	663			

X: متناسب با قدرت الکترو موتور تغییر می یابد.

n ≈ 2900 rpm

پمپ 32 WKL, WKL

تیپ پمپ	توان P		آمپر A	قطر پروانه D (mm)	قطر فلنج mm		Q آبدھی									
	KW	HP			مکش	رانس	m3/h	H (m)								
								4	6	7	8	9	10	11	12	
WKL 32.1 D	1.1	1.5	2.5	125				22.5	20.3	19	17.5	15.6	13.7	11.7	*	
WKL 32.1 C	1.5	2	3	130				24.7	22.8	21.5	20	18.3	16.5	14.5	*	
WKL 32.1 B	1.5	2	3	135				27	25.2	24	22.7	21.2	19.4	17.5	*	
WKL 32.1 A	2.2	3	5	140				28.8	27.2	26	25	23.5	22	20	18	
WKL 32.2 D	2.2	3	5	125				45	40.8	38	35	31.3	27.5	23.5	*	
WKL 32.2 C	3	4	6	130				49.5	45.6	43	40	36.5	33	29	*	
WKL 32.2 B	3	4	6	135				54	50.8	48.7	46	42.5	39	35	*	
WKL 32.2 A	4	5.5	8	140				58	55	53.2	50.8	47.5	44	40	36	
WKL 32.3 D	4	5.5	8	125				66.5	61.5	58	54	50	45	39	*	
WKL 32.3 C	4	5.5	8	130				73.5	68	64.4	60.5	56	50.5	44.5	*	
WKL 32.3 B	4	5.5	8	135				80.5	76.2	73	69	63.7	58.5	52.5	*	
WKL 32.3 A	5.5	7.5	11	140				86.5	82.6	79.7	76	71.4	66.5	60.8	54	
WKL 32.4 D	5.5	7.5	11	125				88	81.6	76.7	70.2	62.5	55	47	*	
WKL 32.4 C	5.5	7.5	11	130				97	91	86	80	73	66	58	*	
WKL 32.4 B	5.5	7.5	11	135				107	101	97.2	92	85	78	70	*	
WKL 32.4 A	7.5	10	15	140	40	32	H (m)	115	110	106	102	95.5	89	81.5	72	
WKL 32.5 D	5.5	7.5	11	125				113	103	95.6	87.5	78	68.7	58.7	*	
WKL 32.5 C	7.5	10	15	130				124	115	108	100	91.2	82.5	72.5	*	
WKL 32.5 B	7.5	10	15	135				135	127	121	115	106	97	87.5	*	
WKL 32.5 A	11	15	22.5	140				145	138	133	127	119	111	102	90	
WKL 32.6 D	7.5	10	15	125				135	122	114	105	93.5	82	70.5	*	
WKL 32.6 C	7.5	10	15	130				149	137	129	120	110	99	88	*	
WKL 32.6 B	11	15	22.5	135				163	152	145	137	127	116	104	*	
WKL 32.6 A	11	15	22.5	140				174	165	160	152	143	134	122	109	
WKL 32.7 D	11	15	22.5	125				158	143	134	123	110	96.2	82.2	*	
WKL 32.7 C	11	15	22.5	130				173	160	151	140	128	116	102	*	
WKL 32.7 B	11	15	22.5	135				189	179	171	161	149	137	123	*	
WKL 32.7 A	11	15	22.5	140				203	193	186	178	167	155	143	127	
WKL 32.8 D	11	15	22.5	125				180	164	153	140	125	110	94	*	
WKL 32.8 C	11	15	22.5	130				198	183	172	160	146	132	116	*	
WKL 32.8 B	11	15	22.5	135				216	203	195	184	170	156	140	*	
WKL 32.8 A	15	20	30	140				232	221	213	203	191	178	164	146	

H	m	10.6	21	37	52	70	91	113	137	162	186	210	235
	ft	35	70	120	170	230	300	370	450	530	610	690	770

Q	m3/h	4	6	7	8	9	10	11	12
	g.p.m	15	23	26.5	30	34	38	42	45

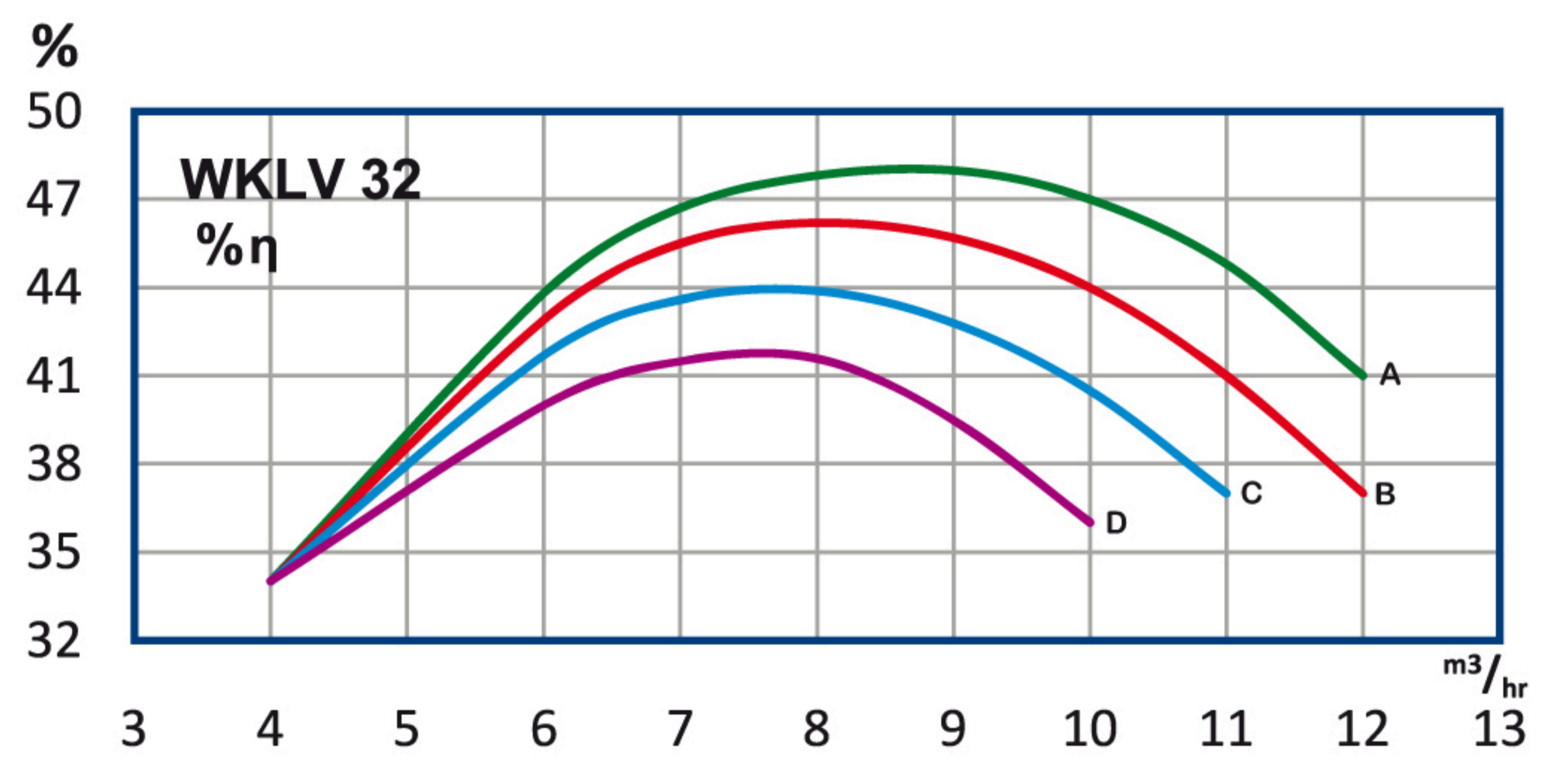
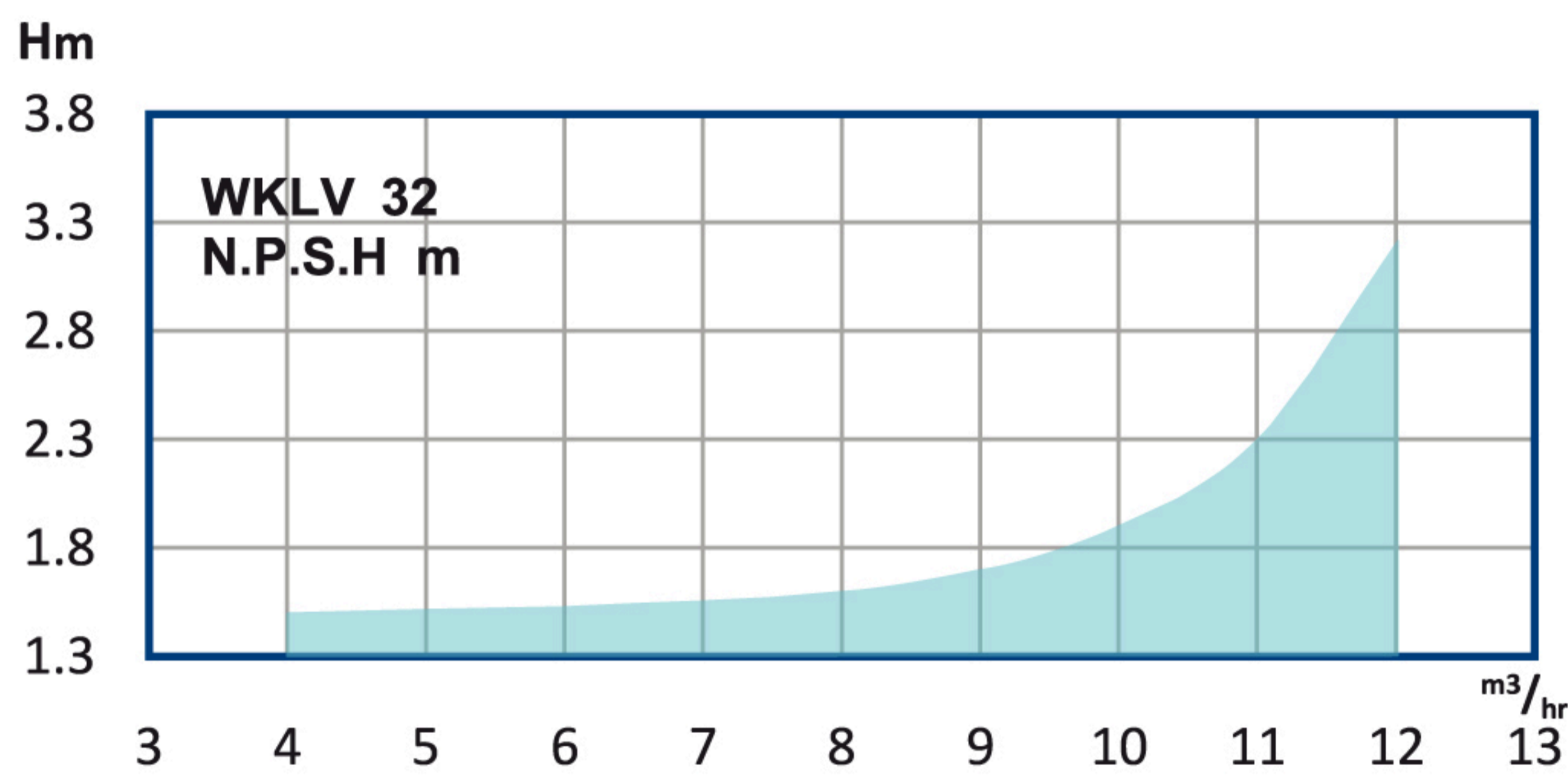
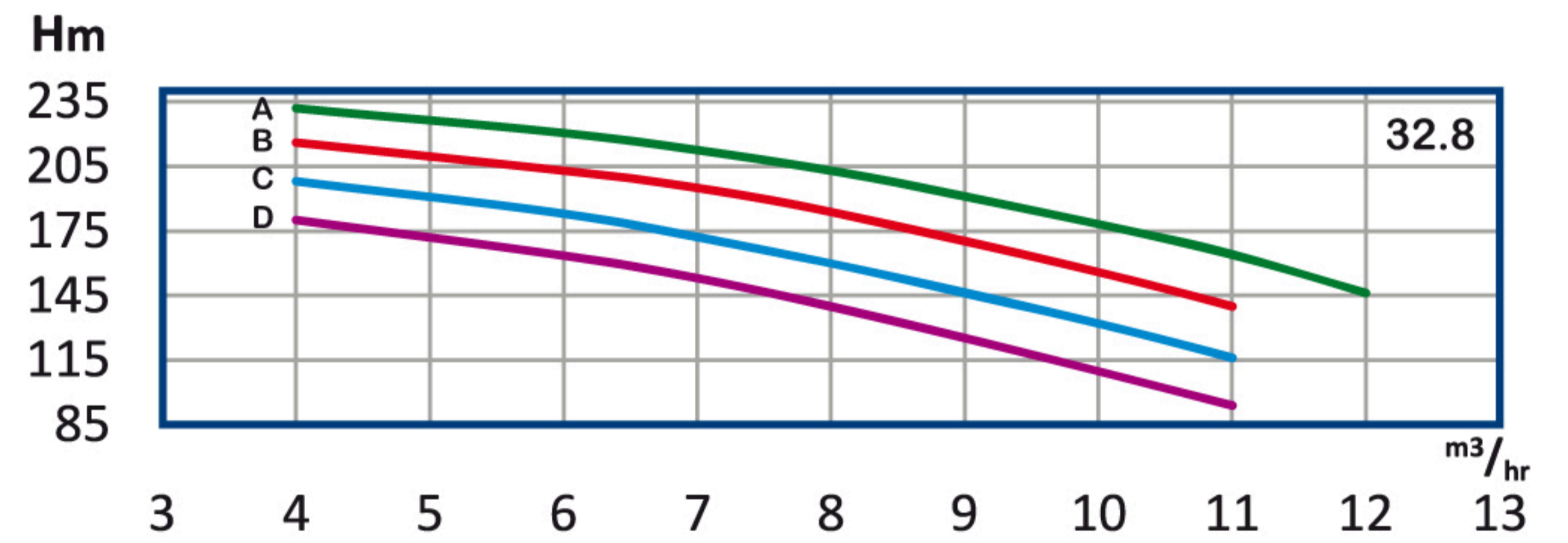
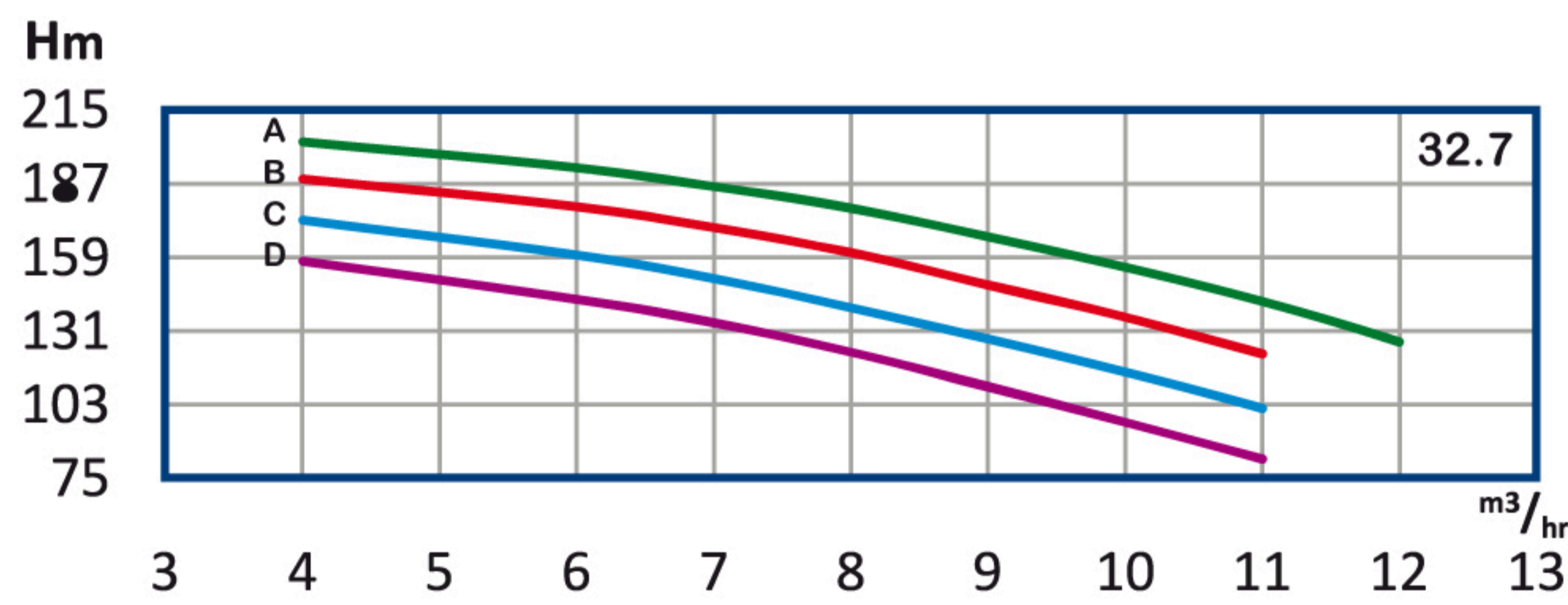
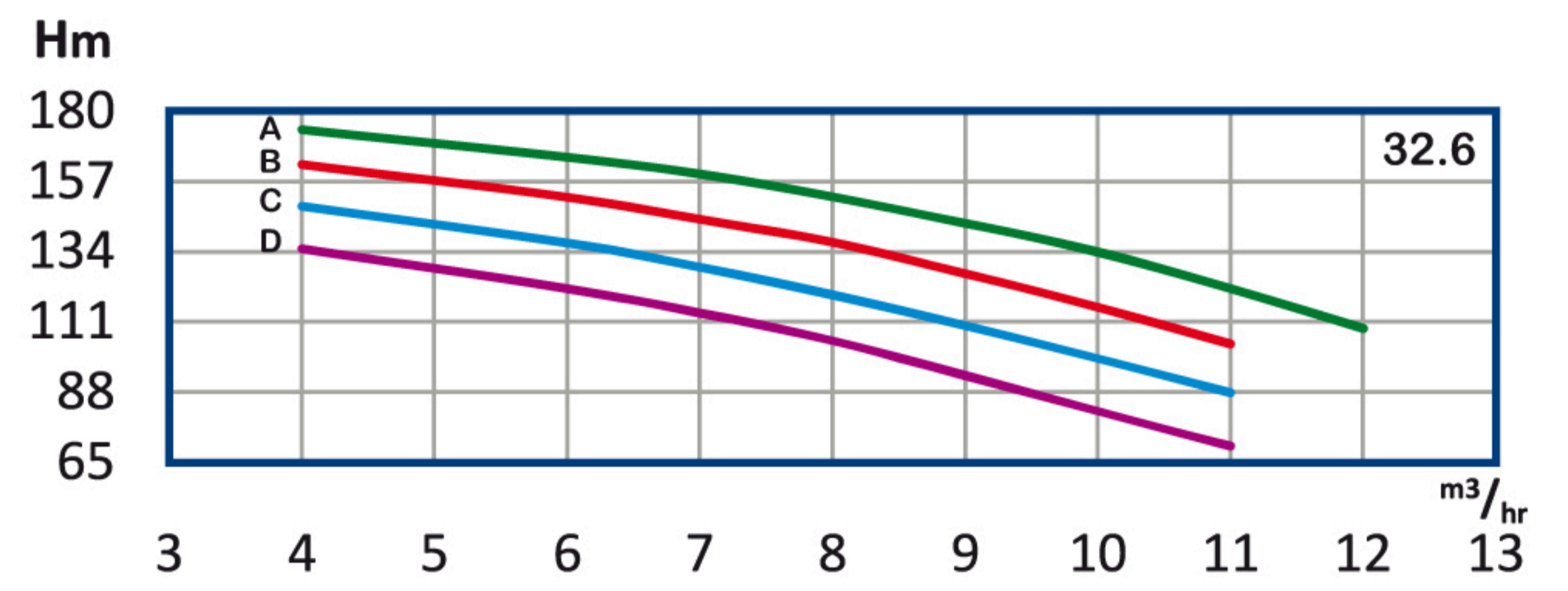
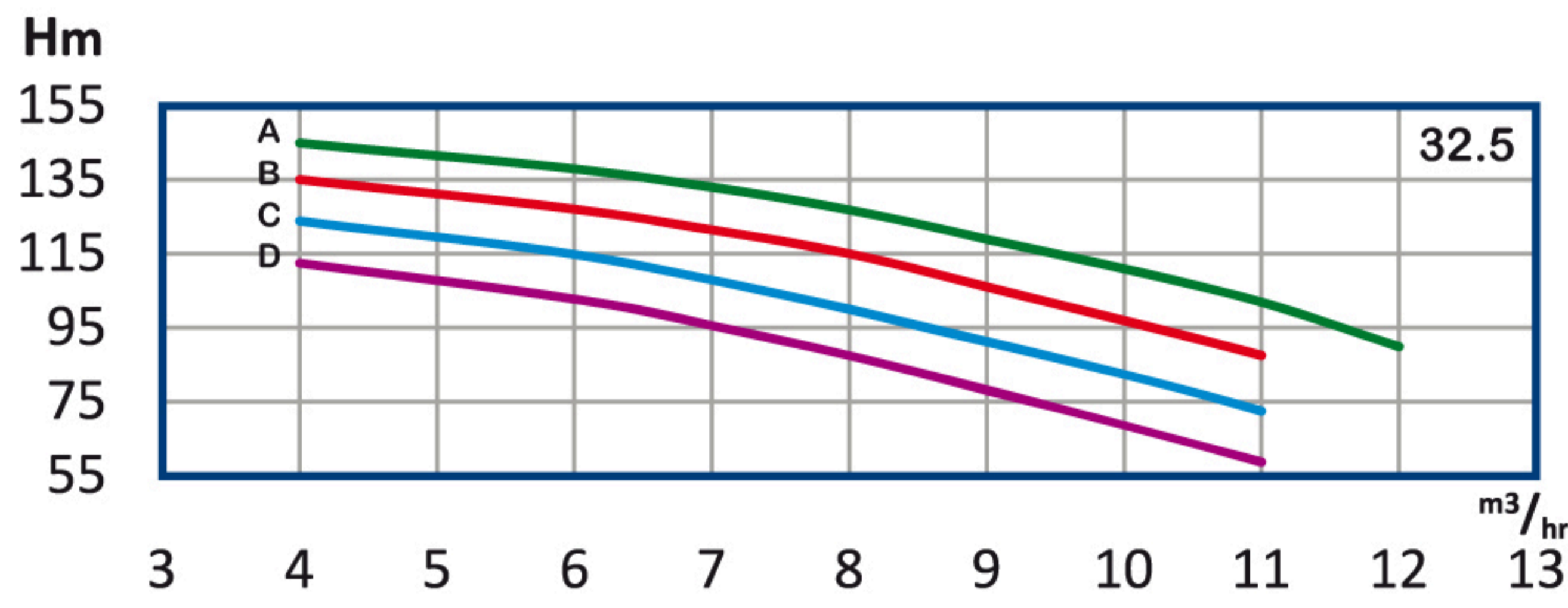
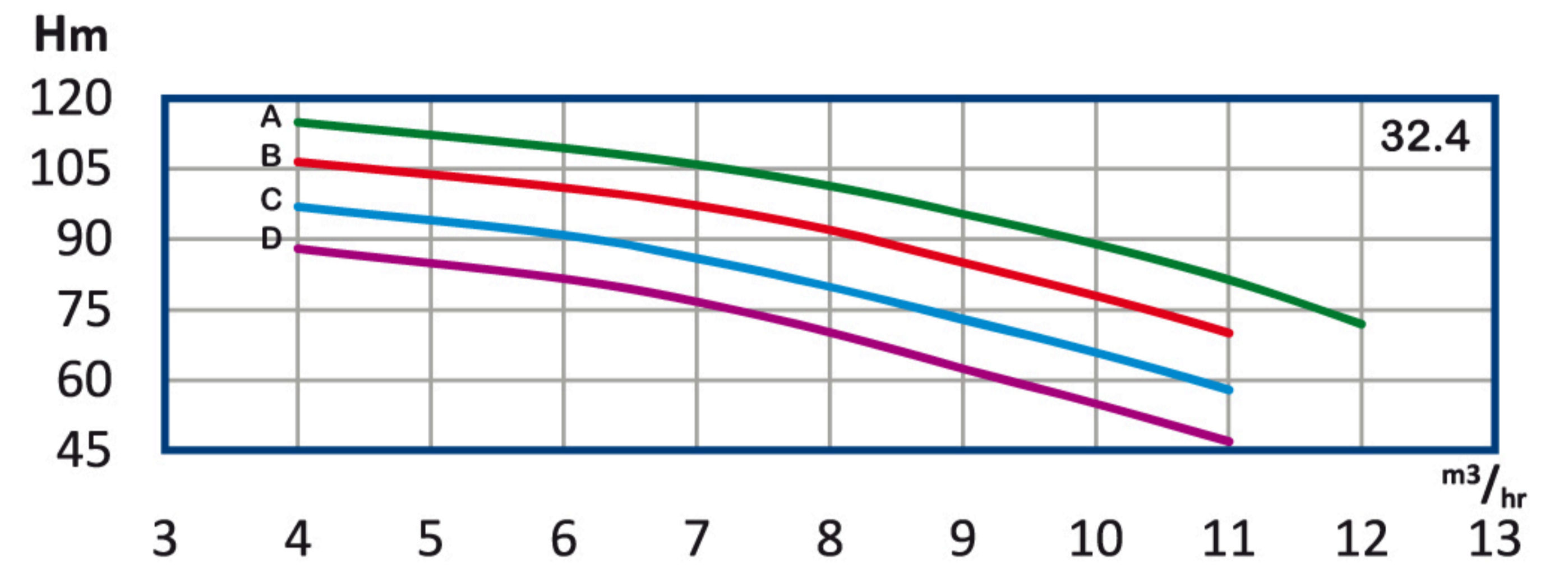
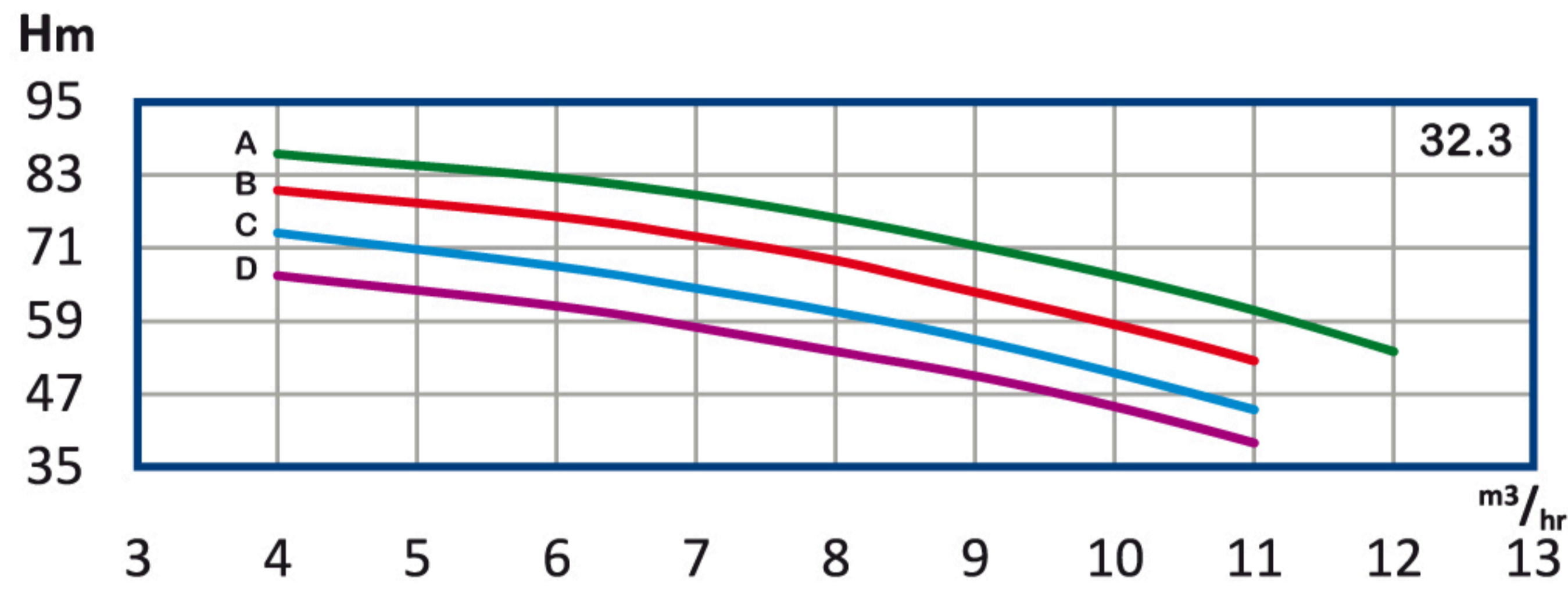
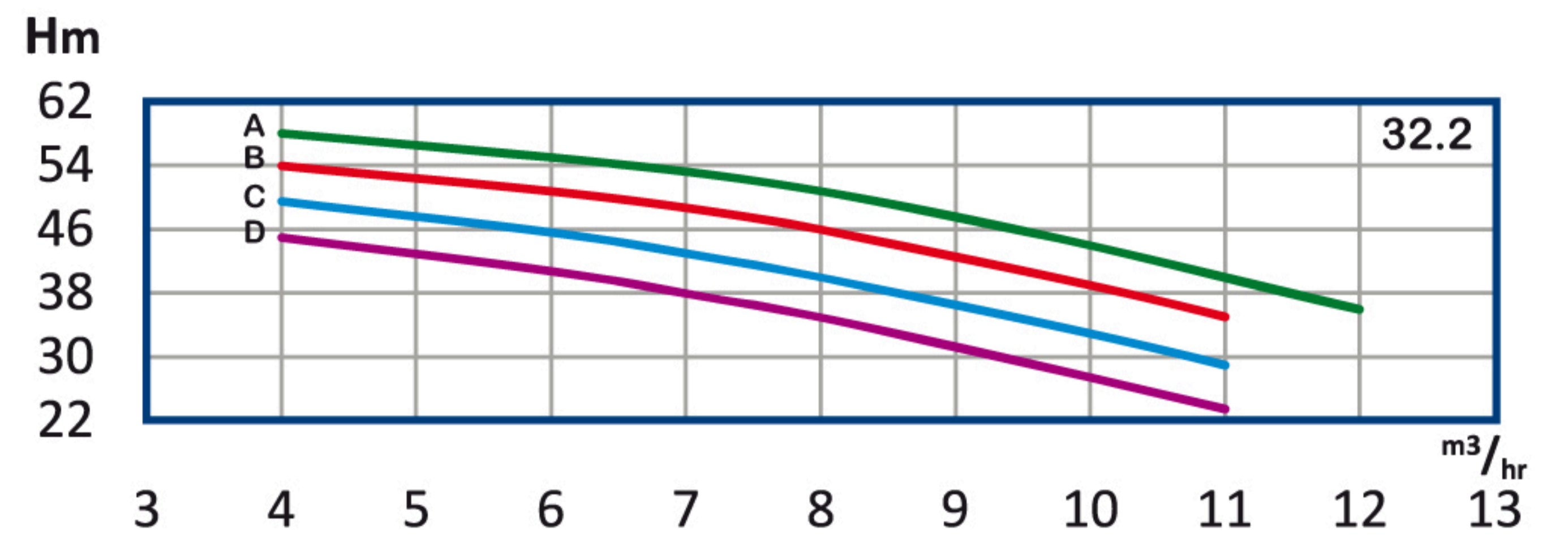
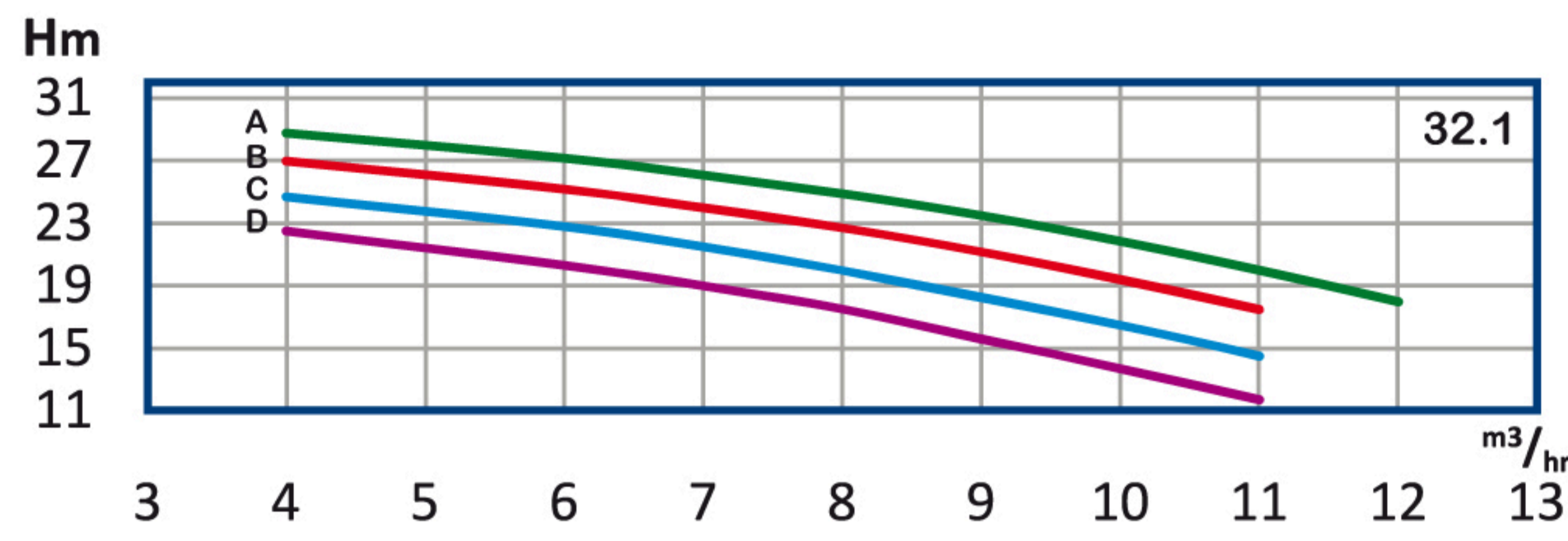

n≈ 2900 rpm

پمپ 32 WKLW , WKL

تیپ پمپ	توان P		آمپر A	قطر پروانه D (mm)	قطر فلنج mm		Q آبدھی								
	KW	HP			مکش	رانس	m ³ /h	4	6	7	8	9	10	11	12
							l/s	1.11	1.67	1.95	2.22	2.5	2.78	3	3.34
WKLW 32.9 D	11	15	22.5	125	40	32	H (m)	202	185	172	158	141	124	106	*
WKLW 32.9 C	11	15	22.5	130				223	206	194	180	164	149	131	*
WKLW 32.9 B	15	20	30	135				243	229	219	207	191	176	158	*
WKLW 32.9 A	15	20	30	140				261	249	240	228	215	200	184	163
WKLW 32.10 D	11	15	22.5	125			H (m)	225	205	191	175	156	138	118	*
WKLW 32.10 C	15	20	30	130				248	229	216	200	183	165	145	*
WKLW 32.10 B	15	20	30	135				270	255	243	230	213	195	175	*
WKLW 32.10 A	18.5	25	36	140				291	277	266	254	239	222	204	181

H	m	104	119	134	150	168	186	204	222	241	260	277	296
	ft	340	390	440	490	550	610	670	730	790	850	910	970

Q	m ³ /h	4	6	7	8	9	10	11	12
	g.p.m	15	23	26.5	30	34	38	42	45

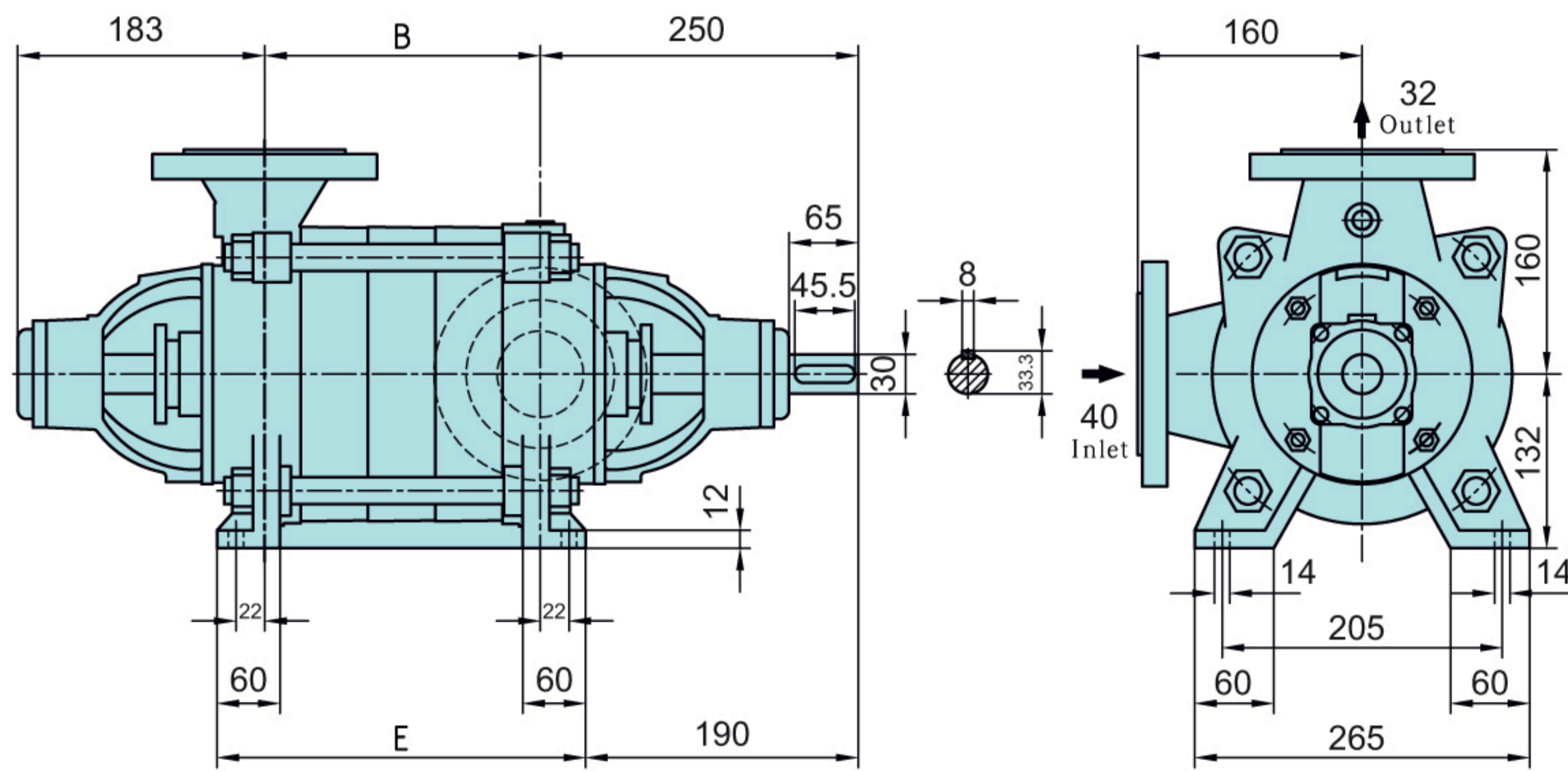
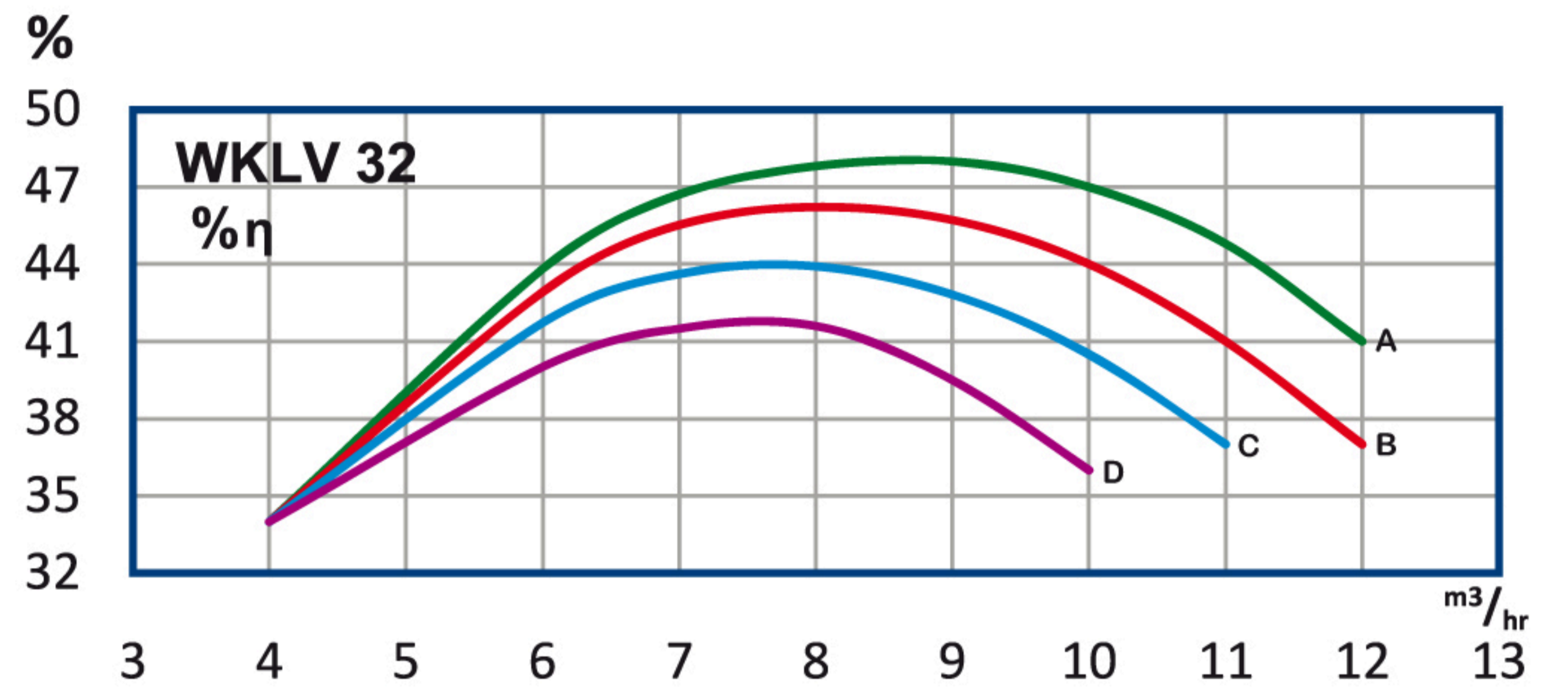
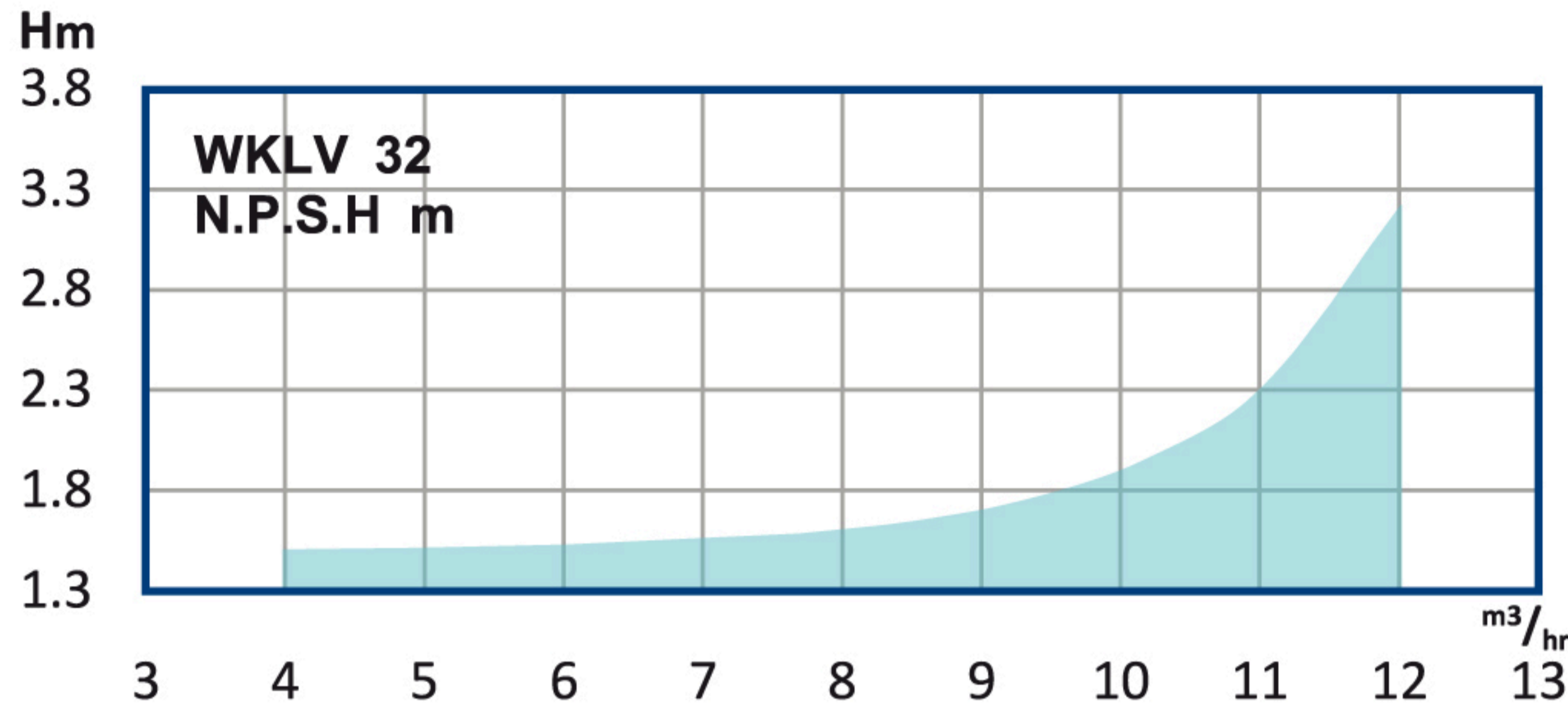
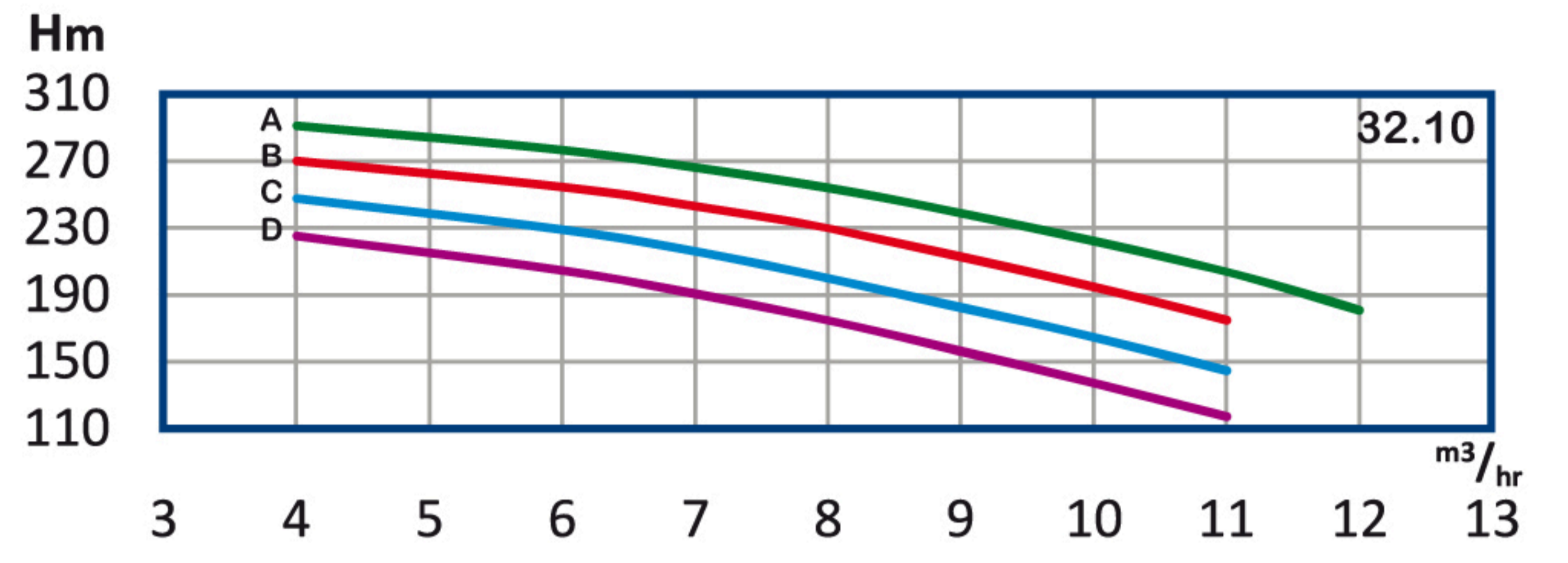
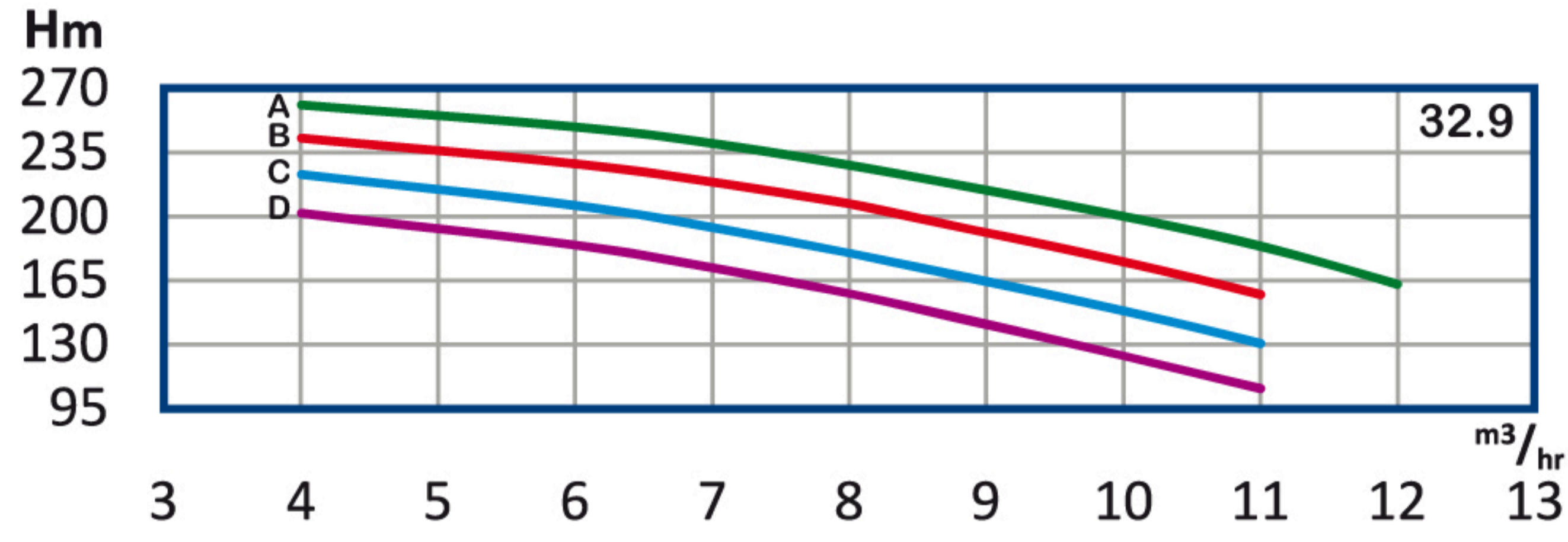

جدول طول پمپ (mm) WKL 32

تعداد طبقه	B	E	تعداد طبقه	B	E
1	82	202	6	322	442
2	130	250	7	370	490
3	178	298	8	418	538
4	226	346	9	466	586
5	274	394	10	514	634

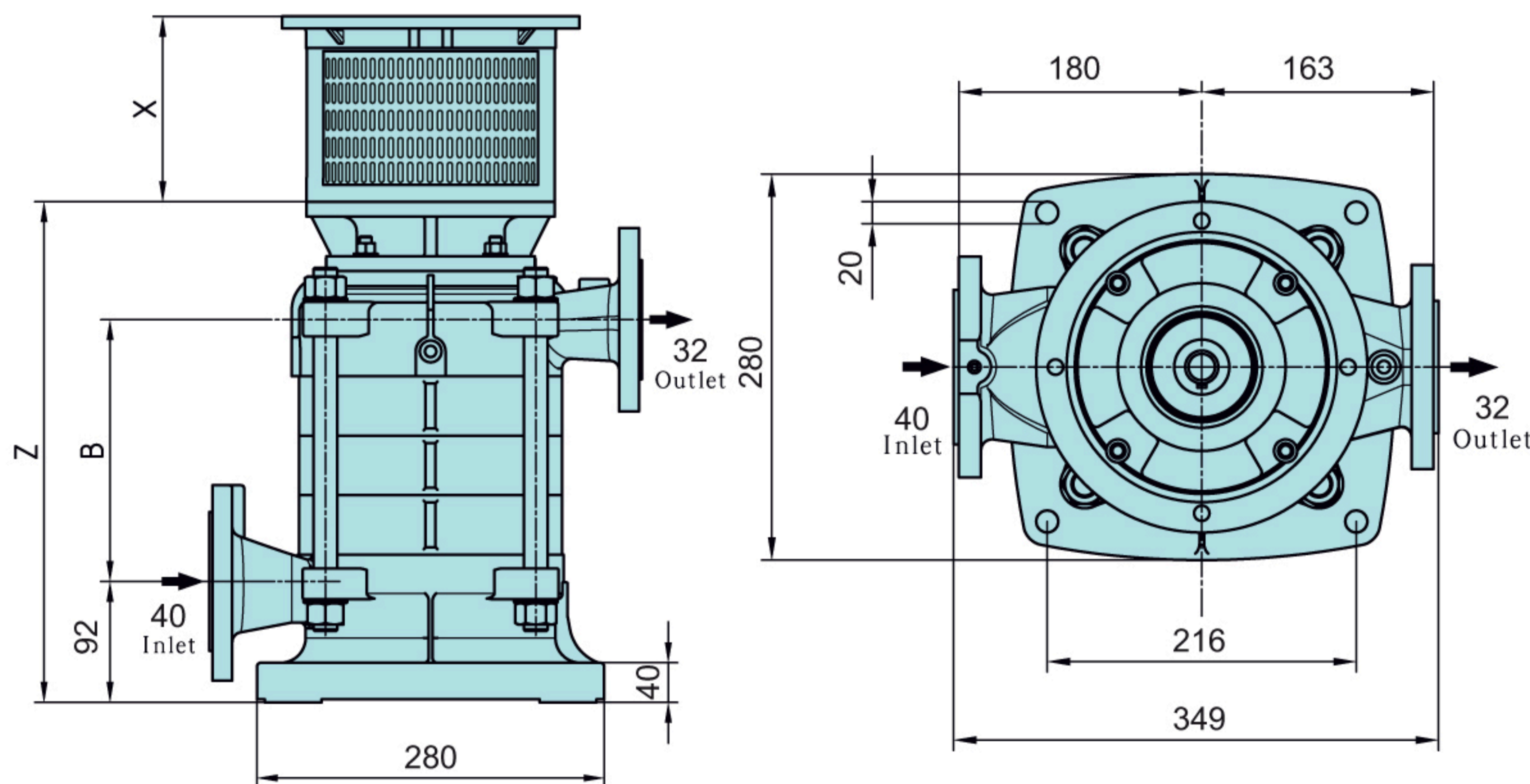

جدول طول پمپ (mm) WKL 32

تعداد طبقه	B	Z	تعداد طبقه	B	Z
1	76	279	6	316	519
2	124	327	7	364	567
3	172	375	8	412	615
4	220	423	9	460	663
5	268	471	10	508	711

X: متناسب با قدرت الکترو موتور تغییر می یابد.

جدول ابعاد پمپ های WKL4 , WKL4 (32-65)

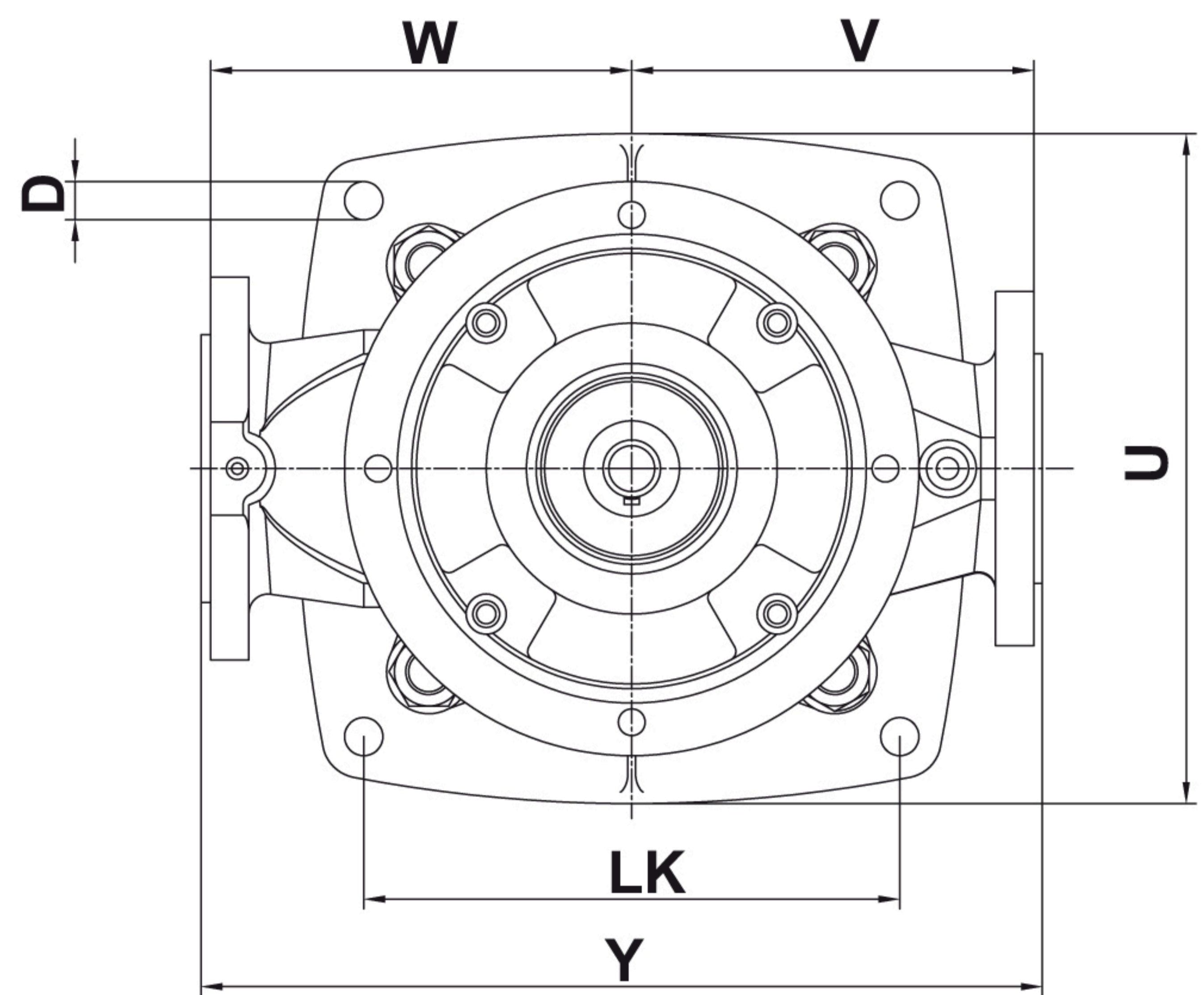
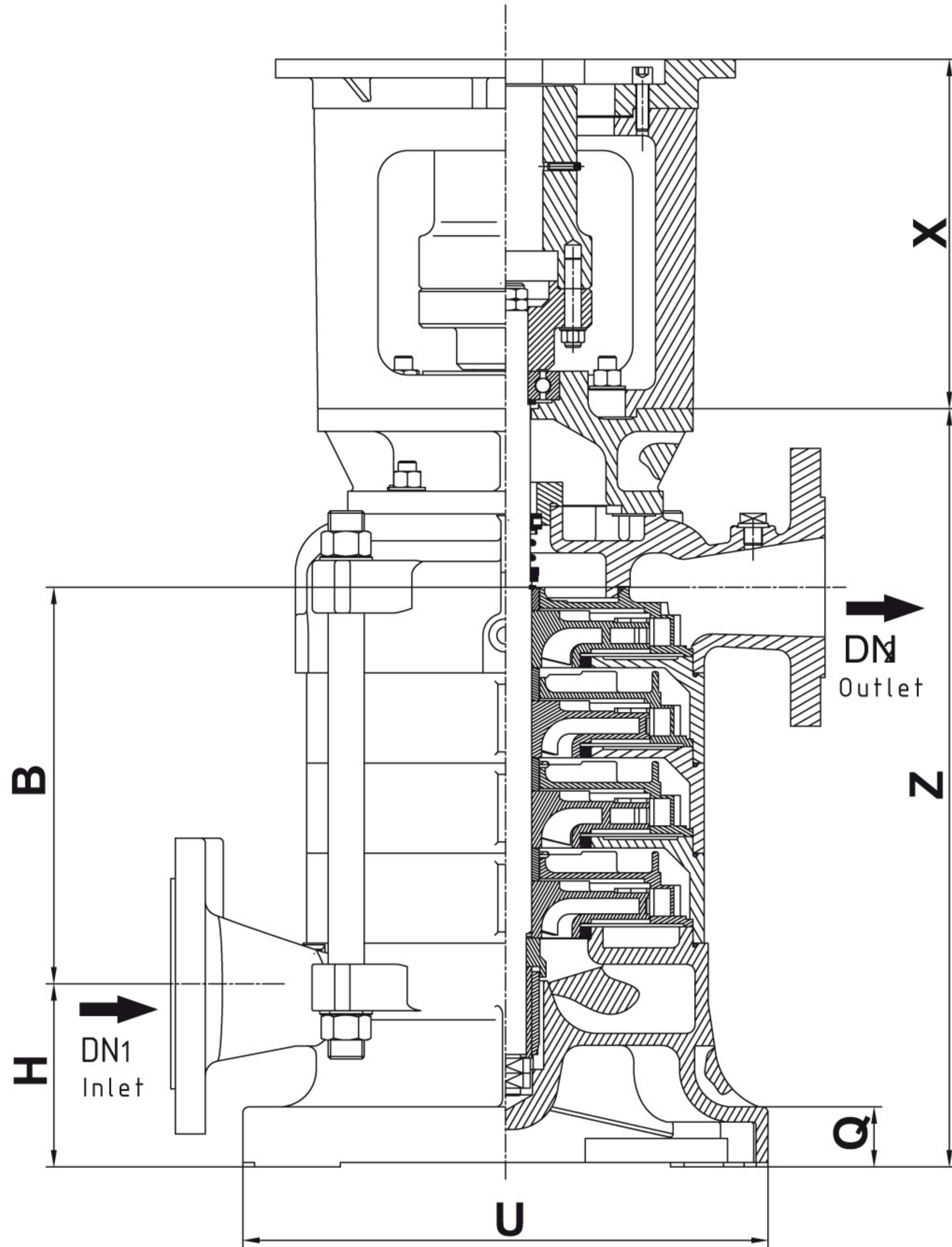

Type	(mm)									
	DN1	DN2	LK	Y	U	D	W	V	Q	H
WKL4 / WKL4 32	40	32	216	349	280	20	180	163	40	92
WKL4 / WKL4 40	50	40	238	370	300	20	192	178	46	94
WKL4 / WKL4 50	65	50	250	392	330	20	206	180	38	103
WKL4 / WKL4 65	80	65	280	430	350	20	220	210	40	122

Type	طول پمپ	(mm)																
		1	2	3	4	5	6	7	8	9	10	11	12	13	14	15	16	17
WKL4 / WKL4 32	B	76	124	172	220	268	316	364	412	460	508	556	604	652	700	748	796	844
	Z	279	327	375	423	471	519	567	615	663	711	759	807	855	903	951	999	1047
WKL4 / WKL4 40	B	89	137	185	233	281	329	377	425	473	521	569	617	665	713	761	809	*
	Z	294	342	390	438	486	534	582	630	678	726	774	822	870	918	966	1014	*
WKL4 / WKL4 50	B	82	137	192	247	302	357	412	467	522	577	632	687	742	797	*	*	*
	Z	310	365	420	475	530	585	640	695	750	805	860	915	970	1025	*	*	*
WKL4 / WKL4 65	B	84	144	204	264	324	384	444	504	564	624	684	747	*	*	*	*	*
	Z	325	385	445	505	565	625	685	745	805	865	925	985	*	*	*	*	*